

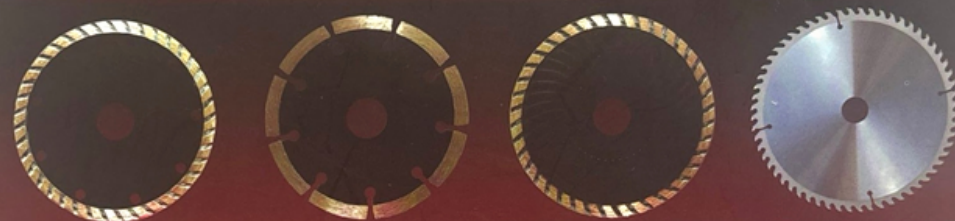

XIANGSHANG TOOLS

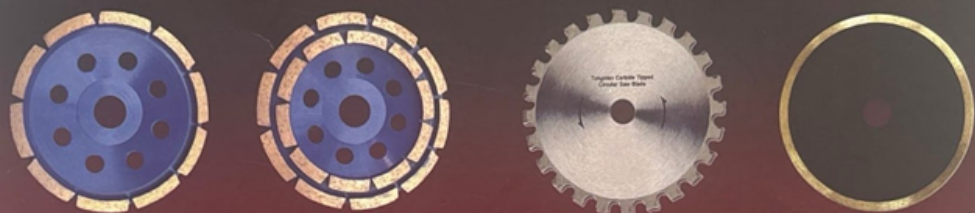
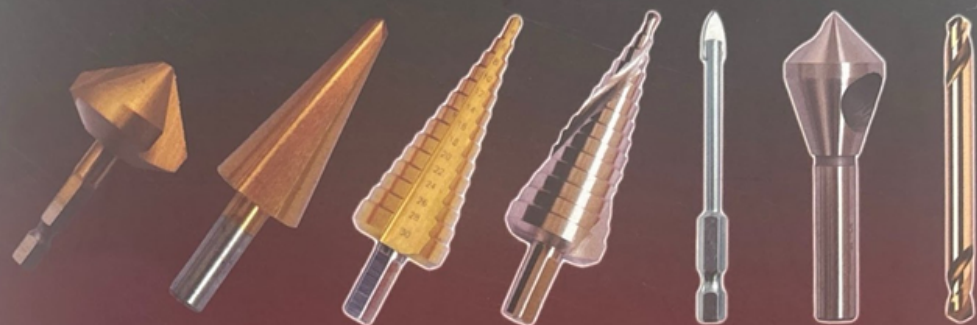

DANYANG XIANGSHANG TOOLS CO.,LTD.
 Jide Industrial Zone, Houxiang Danbei Town, Danyang
 City, Jiangsu Province, China
 Contacts: Mrs. Betty - He fangdong
 MOBILE: 008613706108535
 TEL/FAX: 008651186317508
 WhatsApp/Wechat ID: 008613706108535
 E-mail: hfddg@263.net
 sales@xiangshangtools.com

丹阳市向上工具有限公司

DANYANG XIANGSHANG TOOLS CO.,LTD.



扫一扫手机端访问



添加好友，随时咨询

公司简介 Brief introduction

丹阳市向上工具有限公司位于美丽富饶的长江三角洲—丹阳市后巷镇，东距常州航空港仅十五公里，北临长江黄金中岸。沪宁高速、312国道、沪宁铁路穿境而过。交通地理位置十分便捷。

公司专业生产各种麻花钻、建工钻、电锤钻、金钢石锯片和木工锯片等系列产品。公司技术力量雄厚，设备精良，检测手段先进，产品质量稳定可靠。产品主要出口欧洲及东南亚等国家地区，深得用户好评。

公司一贯奉行“奋发向上、求实创新”的企业精神，遵循“用户至上、质量第一、服务周全”的企业宗旨，强化内部管理，使企业的整体素质不断提高。

精良的生产设备，先进的加工工艺，齐全的检测手段，完善的质保体系，使企业发展和取信于用户提供了根本保证。公司员工不懈努力、精益求精，推出了极具竞争力的产品价格和供货速度。完善的服务质量，以求达到尽善尽美的境界。

热忱欢迎新老客户光临洽谈合作!

DanYang XiangShang Tools Co.,Ltd. is located in Houxiang Town, Danyang City- the beautiful and rich Yangtze River Delta. The traffic here is very convenient.

Our company mainly produce all kinds of Hss twist drill(DIN338,DIN340,DIN1897,DIN345 etc.), Hss Step Drill bit, Hss conical drill bit, Masonry drill bits, Electric hammer drill ,Diamond Cutting blade and TCT Saw blade for wood &aluminium etc. We have strong technical force, excellent equipments and advanced detection methods. Our Products are mainly exported to EUROPEAN markets and Southeast Asia countries and received highly reputations by all our final users.

Our company always pursue the spirits of "enthusiastic, realistic and innovation". Customers first, Quality first with comprehensive services are our company's manage rule! We always strengthen our internal management so that our company continuously improve the overall quality and after-sold services.

We warmly welcome new and old customers to establish cooperations!

Hss Straight Shank Twist Drill-DIN338



D	L1	L2	D	L1	L2	D	L1	L2
0.2	19	2.5	2.85	61	33	9.6	133	87
0.22	19	2.5	2.9	61	33	9.7	133	87
0.25	19	3	2.95	61	33	9.8	133	87
0.28	19	3	3	61	33	9.9	133	87
0.3	19	3	3.1	65	36	10	133	87
0.32	19	4	3.2	65	36	10.1	133	87
0.35	19	4	3.3	65	36	10.2	133	87
0.38	19	4	3.4	70	39	10.3	133	87
0.4	20	5	3.5	70	39	10.4	133	87
0.42	20	5	3.6	70	39	10.5	133	87
0.45	20	5	3.7	70	39	10.6	133	87
0.48	20	5	3.8	75	43	10.7	142	94
0.5	22	6	3.9	75	43	10.8	142	94
0.52	22	6	4	75	43	10.9	142	94
0.55	24	7	4.1	75	43	11	142	94
0.58	24	7	4.2	75	43	11.1	142	94
0.6	24	7	4.3	80	47	11.2	142	94
0.62	26	8	4.4	80	47	11.3	142	94
0.65	26	8	4.5	80	47	11.4	142	94
0.68	28	9	4.6	80	47	11.5	142	94
0.7	28	9	4.7	80	47	11.6	142	94
0.72	28	9	4.8	86	52	11.7	142	94
0.75	28	9	4.9	86	52	11.8	142	94
0.78	30	10	5	86	52	11.9	151	101
0.8	30	10	5.1	86	52	12	151	101
0.82	30	10	5.2	86	52	12.1	151	101
0.85	30	10	5.3	86	52	12.2	151	101
0.88	32	11	5.4	93	57	12.3	151	101
0.9	32	11	5.5	93	57	12.4	151	101
0.92	32	11	5.6	93	57	12.5	151	101
0.95	32	11	5.7	93	57	12.6	151	101
0.98	34	12	5.8	93	57	12.7	151	101
1	34	12	5.9	93	57	12.8	151	101
1.05	34	12	6	93	57	12.9	151	101
1.1	36	14	6.1	101	63	13	151	101
1.15	36	14	6.2	101	63	13.1	151	101
1.2	38	16	6.3	101	63	13.2	151	101
1.25	38	16	6.4	101	63	13.3	160	108
1.3	38	16	6.5	101	63	13.4	160	108
1.35	40	18	6.6	101	63	13.5	160	108
1.4	40	18	6.7	101	63	13.6	160	108
1.45	40	18	6.8	109	69	13.7	160	108
1.5	40	18	6.9	109	69	13.8	160	108
1.55	43	20	7	109	69	13.9	160	108
1.6	43	20	7.1	109	69	14	160	108
1.65	43	20	7.2	109	69	14.2	169	114
1.7	43	20	7.3	109	69	14.5	169	114
1.75	46	22	7.4	109	69	14.75	169	114
1.8	46	22	7.5	109	69	15	169	114
1.85	46	22	7.6	117	75	15.25	178	120
1.9	46	22	7.7	117	75	15.5	178	120
1.95	49	24	7.8	117	75	15.75	178	120
2	49	24	7.9	117	75	16	178	120
2.05	49	24	8	117	75	16.25	184	125
2.1	49	24	8.1	117	75	16.5	184	125
2.15	53	27	8.2	117	75	16.75	184	125
2.2	53	27	8.3	117	75	17	184	125
2.25	53	27	8.4	117	75	17.25	191	130
2.3	53	27	8.5	117	75	17.5	191	130
2.35	53	27	8.6	125	81	17.75	191	130
2.4	57	30	8.7	125	81	18	191	130
2.45	57	30	8.8	125	81	18.25	198	135
2.5	57	30	8.9	125	81	18.5	198	135
2.55	57	30	9	125	81	18.75	198	135
2.6	57	30	9.1	125	81	19	198	135
2.65	57	30	9.2	125	81	19.25	205	140
2.7	61	33	9.3	125	81	19.5	205	140
2.75	61	33	9.4	125	81	19.75	205	140
2.8	61	33	9.5	125	81	20	205	140

Hss Straight Shank Twist Drill-DIN340(Long Series)



D	L1	L2	D	L1	L2	D	L1	L2
1.0	56	33	5.8	139	91	10.6	184	121
1.1	60	37	5.9	139	91	10.7	195	128
1.2	65	41	6.0	139	91	10.8	195	128
1.3	65	41	6.1	148	97	10.9	195	128
1.4	70	45	6.2	148	97	11.0	195	128
1.5	70	45	6.3	148	97	11.1	195	128
1.6	76	50	6.4	148	97	11.2	195	128
1.7	76	50	6.5	148	97	11.3	195	128
1.8	80	53	6.6	148	97	11.4	195	128
1.9	80	53	6.7	148	97	11.5	195	128
2.0	85	56	6.8	156	102	11.6	195	128
2.1	85	56	6.9	156	102	11.7	195	128
2.2	90	56	7.0	156	102	11.8	195	128
2.3	90	56	7.1	156	102	11.9	205	134
2.4	95	62	7.2	156	102	12.0	205	134
2.5	95	62	7.3	156	102	12.1	205	134
2.6	95	62	7.4	156	102	12.2	205	134
2.7	100	66	7.5	156	102	12.3	205	134
2.8	100	66	7.6	165	109	12.4	205	134
2.9	100	66	7.7	165	109	12.5	205	134
3.0	100	66	7.8	165	109	12.6	205	134
3.1	106	69	7.9	165	109	12.7	205	134
3.2	106	69	8.0	165	109	12.8	205	134
3.3	106	69	8.1	165	109	12.9	205	134
3.4	110	73	8.2	165	109	13.0	205	134
3.5	110	73	8.3	165	109	13.1	205	134
3.6	110	73	8.4	165	109	13.2	205	134
3.7	110	73	8.5	165	109	13.3	214	140
3.8	119	78	8.6	175	115	13.4	214	140
3.9	119	78	8.7	175	115	13.5	214	140
4.0	119	78	8.8	175	115	13.6	214	140
4.1	119	78	8.9	175	115	13.7	214	140
4.2	119	78	9.0	175	115	13.8	214	140
4.3	126	82	9.1	175	115	13.9	214	140
4.4	126	82	9.2	175	115	14.0	214	140
4.5	126	82	9.3	175	115	14.5	220	144
4.6	126	82	9.4	175	115	15.0	220	144
4.7	126	82	9.5	175	115	15.5	227	149
4.8	132	87	9.6	184	121	16.0	227	149
4.9	132	87	9.7	184	121	16.5	235	154
5.0	132	87	9.8	184	121	17.0	235	154
5.1	132	87	9.9	184	121	17.5	241	158
5.2	132	87	10.0	184	121	18.0	241	158
5.3	132	87	10.1	184	121	18.5	247	162
5.4	139	91	10.2	184	121	19.0	247	162
5.5	139	91	10.3	184	121	19.5	254	166
5.6	139	91	10.4	184	121	20.0	254	166
5.7	139	91	10.5	184	121			

Hss Reduced Shank Twist Drill-DIN338



D	L1	L2	d	D	L1	L2	d
10.5	133	87	10.0	13.5	160	108	13.0
11.0	142	94	10.0	14.0	160	108	13.0
11.5	142	94	10.0	14.5	169	114	13.0
12.0	151	101	10.0	15.0	169	114	13.0
12.5	151	101	10.0	15.5	178	120	13.0
13.0	151	101	10.0	16.0	178	120	13.0
13.5	160	108	10.0	16.5	184	125	13.0
14.0	160	108	10.0	17.0	184	125	13.0
14.5	169	114	10.0	17.5	191	130	13.0
15.0	169	114	10.0	18.0	191	130	13.0
15.5	178	120	10.0	18.5	198	135	13.0
16.0	178	120	10.0	19.0	198	135	13.0
16.5	184	125	10.0	19.5	205	140	13.0
17.0	184	125	10.0	20.0	205	140	13.0
17.5	191	130	10.0	21.0	205	145	13.0
18.0	191	130	10.0	22.0	210	150	13.0
18.5	198	135	10.0	23.0	215	155	13.0
19.0	198	135	10.0	24.0	220	160	13.0
19.5	205	140	10.0	25.0	220	160	13.0
20.0	205	140	10.0	26.0	235	165	13.0
10.5mm Reduced shank				27.0	235	170	13.0
13.0mm Reduced shank				28.0	235	170	13.0
3/8" Reduced shank				29.0	240	175	13.0
1/2" Reduced shank				30.0	240	175	13.0

Hss Straight Shank Twist Drill-DIN1869(Extra Long)



DIN 1869-I			DIN 1869-II			DIN 1869-III		
D	L1	L2	D	L1	L2	D	L1	L2
2.0	125	85	2.0	160	110	2.0	200	135
2.5	140	95	2.5	180	120	2.5	225	150
3.0	150	100	3.0	190	130	3.0	240	160
3.5	165	115	3.5	210	145	3.5	265	180
4.0	175	120	4.0	220	150	4.0	280	190
4.5	185	125	4.5	235	160	4.5	295	200
5.0	195	135	5.0	245	170	5.0	315	210
5.5	205	140	5.5	260	180	5.5	330	225
6.0	205	140	6.0	260	180	6.0	330	225
6.5	215	150	6.5	275	190	6.5	350	235
7.0	225	155	7.0	290	200	7.0	370	250
7.5	225	155	7.5	290	200	7.5	370	250
8.0	240	165	8.0	305	210	8.0	390	265
8.5	240	165	8.5	305	210	8.5	390	265
9.0	250	175	9.0	320	220	9.0	410	280
9.5	250	175	9.5	320	220	9.5	410	280
10.0	265	185	10.0	340	235	10.0	430	295
10.5	265	185	10.5	340	235	10.5	430	295
11.0	280	195	11.0	365	250	11.0	455	310
11.5	280	195	11.5	365	250	11.5	455	310
12.0	295	205	12.0	375	260	12.0	480	330
12.5	295	205	12.5	375	260	12.5	480	330
13.0	295	205	13.0	375	260	13.0	480	330

Hss Straight Shank Twist Drill-DIN1897(Short Series)



D	L1	L2	D	L1	L2	D	L1	L2
1.0	26	6	5.8	66	28	10.6	89	43
1.1	28	7	5.9	66	28	10.7	95	47
1.2	30	8	6.0	66	28	10.8	95	47
1.3	30	8	6.1	70	31	10.9	95	47
1.4	32	9	6.2	70	31	11.0	95	47
1.5	32	9	6.3	70	31	11.1	95	47
1.6	34	10	6.4	70	31	11.2	95	47
1.7	34	10	6.5	70	31	11.3	95	47
1.8	36	11	6.6	70	31	11.4	95	47
1.9	36	11	6.7	70	31	11.5	95	47
2.0	38	12	6.8	74	34	11.6	95	47
2.1	38	12	6.9	74	34	11.7	95	47
2.2	40	13	7.0	74	34	11.8	95	47
2.3	40	13	7.1	74	34	11.9	102	51
2.4	43	14	7.2	74	34	12.0	102	51
2.5	43	14	7.3	74	34	12.1	102	51
2.6	43	14	7.4	74	34	12.2	102	51
2.7	46	16	7.5	74	34	12.3	102	51
2.8	46	16	7.6	79	37	12.4	102	51
2.9	46	16	7.7	79	37	12.5	102	51
3.0	46	16	7.8	79	37	12.6	102	51
3.1	49	18	7.9	79	37	12.7	102	51
3.2	49	18	8.0	79	37	12.8	102	51
3.3	49	18	8.1	79	37	12.9	102	51
3.4	52	20	8.2	79	37	13.0	102	51
3.5	52	20	8.3	79	37	13.1	102	51
3.6	52	20	8.4	79	37	13.2	102	51
3.7	52	20	8.5	79	37	13.3	102	51
3.8	55	22	8.6	84	40	13.4	107	54
3.9	55	22	8.7	84	40	13.5	107	54
4.0	55	22	8.8	84	40	13.6	107	54
4.1	55	22	8.9	84	40	13.7	107	54
4.2	55	22	9.0	84	40	13.8	107	54
4.3	58	24	9.1	84	40	13.9	107	54
4.4	58	24	9.2	84	40	14.0	107	54
4.5	58	24	9.3	84	40	14.5	111	56
4.6	58	24	9.4	84	40	15.0	111	56
4.7	58	24	9.5	84	40	15.5	115	58
4.8	62	26	9.6	89	43	16.0	115	58
4.9	62	26	9.7	89	43	16.5	119	60
5.0	62	26	9.8	89	43	17.0	119	60
5.1	62	26	9.9	89	43	17.5	123	62
5.2	62	26	10.0	89	43	18.0	123	62
5.3	66	28	10.1	89	43	18.5	127	64
5.4	66	28	10.2	89	43	19.0	127	64
5.5	66	28	10.3	89	43	19.5	131	66
5.6	66	28	10.4	89	43	20.0	131	66
5.7	66	28	10.5	89	43			

Hss Straight Shank Twist Drill-Jobber Length



D	L1	L2	D	L1	L2
1/64"	3/4"	3/16"	25/64"	5-1/8"	3-3/4"
1/32"	1-3/8"	1/2"	13/32"	5-1/4"	3-7/8"
3/64"	1-3/4"	3/4"	27/64"	5-3/8"	3-15/16"
1/16"	1-7/8"	7/8"	7/16"	5-1/2"	4-1/16"
5/64"	2"	1"	29/64"	5-5/8"	4-3/16"
3/32"	2-1/4"	1-1/4"	15/32"	5-3/4"	4-5/16"
7/64"	2-5/8"	1-1/2"	31/64"	5-7/8"	4-3/8"
1/8"	2-3/4"	1-5/8"	1/2"	6"	4-1/2"
9/64"	2-7/8"	1-3/4"	33/64"	6-5/8"	4-13/16"
5/32"	3-1/8"	2"	17/32"	6-5/8"	4-13/16"
11/64"	3-1/4"	2-1/8"	35/64"	6-5/8"	4-13/16"
3/16"	3-1/2"	2-5/16"	9/16"	6-5/8"	4-13/16"
13/64"	3-5/8"	2-7/16"	37/64"	6-5/8"	4-13/16"
7/32"	3-3/4"	2-1/2"	19/32"	7-1/8"	5-3/16"
15/64"	3-7/8"	2-5/8"	39/64"	7-1/8"	5-3/16"
1/4"	4"	2-3/4"	5/8"	7-1/8"	5-3/16"
17/64"	4-1/8"	2-7/8"	41/64"	7-1/8"	5-3/16"
9/32"	4-1/4"	2-15/16"	21/32"	7-1/8"	5-3/16"
19/64"	4-3/8"	3-1/16"	43/64"	7-5/8"	5-5/8"
5/16"	4-1/2"	3-3/16"	11/16"	7-5/8"	5-5/8"
21/64"	4-5/8"	3-5/16"	45/64"	7-5/8"	5-5/8"
11/32"	4-3/4"	3-7/16"	23/32"	7-5/8"	5-5/8"
23/64"	4-7/8"	3-1/2"	47/64"	7-5/8"	5-5/8"
3/8"	5"	3-5/8"	3/4"	7-5/8"	5-5/8"

Hss Reduced Shank Twist Drill-Jobber Length



D	L1	L2	d	D	L1	L2	d
21/64"	4-5/8"	3-5/16"	5/16"	35/64"	6-5/8"	4-13/16"	1/2"
11/32"	4-3/4"	3-7/16"	5/16"	9/16"	6-5/8"	4-13/16"	1/2"
23/64"	4-7/8"	3-1/2"	5/16"	37/64"	6-5/8"	4-13/16"	1/2"
3/8"	5"	3-5/8"	5/16"	19/32"	7-1/8"	5-3/16"	1/2"
25/64"	5-1/8"	3-3/4"	3/8"	39/64"	7-1/8"	5-3/16"	1/2"
13/32"	5-1/4"	3-7/8"	3/8"	5/8"	7-1/8"	5-3/16"	1/2"
27/64"	5-3/8"	3-15/16"	3/8"	41/64"	7-1/8"	5-3/16"	1/2"
7/16"	5-1/2"	4-1/16"	3/8"	21/32"	7-1/8"	5-3/16"	1/2"
29/64"	5-5/8"	4-3/16"	3/8"	43/64"	7-5/8"	5-5/8"	1/2"
15/32"	5-3/4"	4-5/16"	3/8"	11/16"	7-5/8"	5-5/8"	1/2"
31/64"	5-7/8"	4-3/8"	3/8"	45/64"	7-5/8"	5-5/8"	1/2"
1/2"	6"	4-1/2"	3/8"	23/32"	7-5/8"	5-5/8"	1/2"
33/64"	6-5/8"	4-13/16"	1/2"	47/64"	7-5/8"	5-5/8"	1/2"
17/32"	6-5/8"	4-13/16"	1/2"	3/4"	7-5/8"	5-5/8"	1/2"

Hss Straight Shank Twist Drill-JIS



D	L1	L2	D	L1	L2	D	L1	L2
0.5	22	6	3.7	76	48	8.4	121	87
0.55	24	7	3.8	76	48	8.5	121	87
0.6	24	7	3.9	79	51	8.6	121	87
0.65	26	8	4.0	83	54	8.7	121	87
0.7	28	9	4.1	83	54	8.8	124	89
0.75	28	9	4.2	83	54	8.9	124	89
0.8	30	10	4.3	83	54	9.0	124	89
0.85	30	10	4.4	86	56	9.1	124	89
0.9	32	11	4.5	86	56	9.2	127	92
0.95	32	11	4.6	86	56	9.3	127	92
1.0	34	12	4.7	89	59	9.4	127	92
1.05	34	12	4.8	89	59	9.5	127	92
1.1	3							

Hss Straight Shank Twist Drill-Aircraft Extension



D	L1	L2	D	L1	L2
1/16"	6"	7/8"	1/16"	12"	7/8"
5/64"	6"	1"	5/64"	12"	1"
3/32"	6"	1-1/4"	3/32"	12"	1-1/4"
7/64"	6"	1-1/2"	7/64"	12"	1-1/2"
1/8"	6"	1-5/8"	1/8"	12"	1-5/8"
9/64"	6"	1-3/4"	9/64"	12"	1-3/4"
5/32"	6"	2"	5/32"	12"	2"
11/64"	6"	2-1/8"	11/64"	12"	2-1/8"
3/16"	6"	2-5/16"	3/16"	12"	2-5/16"
13/64"	6"	2-7/16"	13/64"	12"	2-7/16"
7/32"	6"	2-1/2"	7/32"	12"	2-1/2"
15/64"	6"	2-5/8"	15/64"	12"	2-5/8"
1/4"	6"	2-3/4"	1/4"	12"	2-3/4"
17/64"	6"	2-7/8"	17/64"	12"	2-7/8"
9/32"	6"	2-15/16"	9/32"	12"	2-15/16"
19/64"	6"	3-1/16"	19/64"	12"	3-1/16"
5/16"	6"	3-3/16"	5/16"	12"	3-3/16"
21/64"	6"	3-5/16"	21/64"	12"	3-5/16"
11/32"	6"	3-7/16"	11/32"	12"	3-7/16"
23/64"	6"	3-1/2"	23/64"	12"	3-1/2"
3/8"	6"	3-5/8"	3/8"	12"	3-5/8"
25/64"	6"	3-3/4"	25/64"	12"	3-3/4"
13/32"	6"	3-7/8"	13/32"	12"	3-7/8"
27/64"	6"	3-15/16"	27/64"	12"	3-15/16"
7/16"	6"	4-1/16"	7/16"	12"	4-1/16"
29/64"	6"	4-3/16"	29/64"	12"	4-3/16"
15/32"	6"	4-5/16"	15/32"	12"	4-5/16"
31/64"	6"	4-3/8"	31/64"	12"	4-3/8"
1/2"	6"	4-1/2"	1/2"	12"	4-1/2"

Hss Straight Shank Twist Drill-Extra Length



D	L1	L2	D	L1	L2	D	L1	L2
1/8"	8"	6"	1/8"	12"	9"	1/4"	18"	12"
9/64"	8"	6"	9/64"	12"	9"	17/64"	18"	12"
5/32"	8"	6"	5/32"	12"	9"	9/32"	18"	12"
11/64"	8"	6"	11/64"	12"	9"	19/64"	18"	12"
3/16"	8"	6"	3/16"	12"	9"	5/16"	18"	12"
13/64"	8"	6"	13/64"	12"	9"	21/64"	18"	12"
7/32"	8"	6"	7/32"	12"	9"	11/32"	18"	12"
15/64"	8"	6"	15/64"	12"	9"	23/64"	18"	12"
1/4"	8"	6"	1/4"	12"	9"	3/8"	18"	12"
17/64"	8"	6"	17/64"	12"	9"	25/64"	18"	12"
9/32"	8"	6"	9/32"	12"	9"	13/32"	18"	12"
19/64"	8"	6"	19/64"	12"	9"	27/64"	18"	12"
5/16"	8"	6"	5/16"	12"	9"	7/16"	18"	12"
21/64"	8"	6"	21/64"	12"	9"	29/64"	18"	12"
11/32"	8"	6"	11/32"	12"	9"	15/32"	18"	12"
23/64"	8"	6"	23/64"	12"	9"	31/64"	18"	12"
3/8"	8"	6"	3/8"	12"	9"	1/2"	18"	12"
25/64"	8"	6"	25/64"	12"	9"	33/64"	18"	12"
13/32"	8"	6"	13/32"	12"	9"	17/32"	18"	12"
27/64"	8"	6"	27/64"	12"	9"	35/64"	18"	12"
7/16"	8"	6"	7/16"	12"	9"	9/16"	18"	12"
29/64"	8"	6"	29/64"	12"	9"	37/64"	18"	12"
15/32"	8"	6"	15/32"	12"	9"	19/32"	18"	12"
31/64"	8"	6"	31/64"	12"	9"	39/64"	18"	12"
1/2"	8"	6"	1/2"	12"	9"	5/8"	18"	12"
41/64"	18"	12"						
21/32"	18"	12"						
43/64"	18"	12"						
11/16"	18"	12"						
45/64"	18"	12"						
23/32"	18"	12"						
47/64"	18"	12"						
3/4"	18"	12"						



1/2" Shank Hss Twist Drill

铁制 Milled

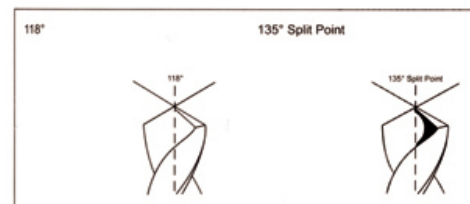

Surface Treatment

01-黑色/Black Oxide



02-黑白/Black Flute & White Shank



03-黑黄/Black Flute & Gold Shank



04-白色/Bright Finish



05-镀钛/Bright Finish + Tin Coated



06-烤黄/Amber Color



1/2" Hss Equal Shank Twist Drill



D	L1	L2	d	D	L1	L2	d
10.0	152	76	9.5	13.0	152	76	12.7
10.5	152	76	9.5	13.5	152	76	12.7
11.0	152	76	9.5	14.0	152	76	12.7
11.5	152	76	9.5	14.5	152	76	12.7
12.0	152	76	9.5	15.0	152	76	12.7
12.5	152	76	9.5	15.5	152	76	12.7
13.0	152	76	9.5	16.0	152	76	12.7
13.5	152	76	9.5	16.5	152	76	12.7
14.0	152	76	9.5	17.0	152	76	12.7
14.5	152	76	9.5	17.5	152	76	12.7
15.0	152	76	9.5	18.0	152	76	12.7
15.5	152	76	9.5	18.5	152	76	12.7
16.0	152	76	9.5	19.0	152	76	12.7
16.5	152	76	9.5	19.5	152	76	12.7
17.0	152	76	9.5	20.0	152	76	12.7
17.5	152	76	9.5	20.5	152	76	12.7
18.0	152	76	9.5	21.0	152	76	12.7
18.5	152	76	9.5	21.5	152	76	12.7
19.0	152	76	9.5	22.0	152	76	12.7
19.5	152	76	9.5	22.5	152	76	12.7
20.0	152	76	9.5	23.0	152	76	12.7
20.5	152	76	9.5	23.5	152	76	12.7
21.0	152	76	9.5	24.0	152	76	12.7
21.5	152	76	9.5	24.5	152	76	12.7
22.0	152	76	9.5	25.0	152	76	12.7
22.5	152	76	9.5	25.5	152	76	12.7
23.0	152	76	9.5	26.0	152	76	12.7
23.5	152	76	9.5	26.5	152	76	12.7
24.0	152	76	9.5	27.0	152	76	12.7
24.5	152	76	9.5	27.5	152	76	12.7
25.0	152	76	9.5	28.0	152	76	12.7
				28.5	152	76	12.7
				29.0	152	76	12.7
				29.5	152	76	12.7
				30.0	152	76	12.7

Hss Taper Shank Twist Drill-DIN345

Can Supply Following Production Technics

轧制 Roll Forged



铣制 Milled

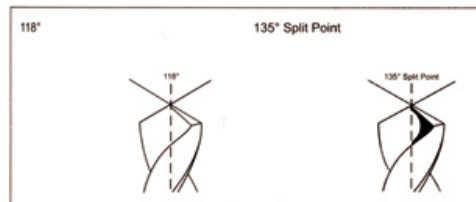

Surface Treatment

01-黑色/Black Oxide



02-黑白/Black Flute & White Shank



03-灰白/Grey Flute & White Edge



04-白色/Bright Finish



05-镀钛/Bright Finish + Tin Coated



Hss Taper Shank Twist Drill-DIN345

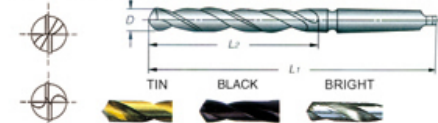

D	L1	L2	Shank	D	L1	L2	Shank	D	L1	L2	Shank
5.0	133	52	1#	24.5	281	160	3#	50.0	369	220	4#
5.2	133	52	1#	25.0	281	160	3#	50.5	374	225	4#
5.5	138	57	1#	25.5	286	165	3#	51.0	412	225	5#
6.0	138	57	1#	26.0	286	165	3#	52.0	412	225	5#
6.2	144	63	1#	26.5	286	165	3#	53.0	412	225	5#
6.5	144	63	1#	27.0	291	170	3#	54.0	417	230	5#
6.8	150	69	1#	27.5	291	170	3#	55.0	417	230	5#
7.0	150	69	1#	28.0	291	170	3#	56.0	417	230	5#
7.5	150	69	1#	28.5	296	175	3#	57.0	422	235	5#
7.8	156	75	1#	29.0	296	175	3#	58.0	422	235	5#
8.0	156	75	1#	29.5	296	175	3#	59.0	422	235	5#
8.5	156	75	1#	30.0	296	175	3#	60.0	422	235	5#
8.8	162	81	1#	30.5	301	180	3#	61.0	427	240	5#
9.0	162	81	1#	31.0	301	180	3#	62.0	427	240	5#
9.5	162	81	1#	31.5	301	180	3#	63.0	427	240	5#
9.8	168	87	1#	31.75	306	185	3#	64.0	432	245	5#
10.0	168	87	1#	32.0	334	185	4#	65.0	432	245	5#
10.5	168	87	1#	32.5	334	185	4#	66.0	432	245	5#
10.8	175	94	1#	33.0	334	185	4#	67.0	432	245	5#
11.0	175	94	1#	33.5	334	185	4#	68.0	437	250	5#
11.5	175	94	1#	34.0	339	190	4#	69.0	437	250	5#
11.8	175	94	1#	34.5	339	190	4#	70.0	437	250	5#
12.0	182	101	1#	35.0	339	190	4#	71.0	437	250	5#
12.5	182	101	1#	35.5	339	190	4#	72.0	442	255	5#
13.0	182	101	1#	36.0	344	195	4#	73.0	442	255	5#
13.2	182	101	1#	36.5	344	195	4#	74.0	442	255	5#
13.5	189	108	1#	37.0	344	195	4#	75.0	442	255	5#
14.0	189	108	1#	37.5	344	195	4#	76.0	447	260	5#
14.25	212	114	2#	38.0	349	200	4#	77.0	514	260	6#
14.5	212	114	2#	38.5	349	200	4#	78.0	514	260	6#
15.0	212	114	2#	39.0	349	200	4#	79.0	514	260	6#
15.25	218	120	2#	39.5	349	200	4#	80.0	514	260	6#
15.5	218	120	2#	40.0	349	200	4#	81.0	519	265	6#
16.0	218	120	2#	40.5	354	205	4#	82.0	519	265	6#
16.25	223	125	2#	41.0	354	205	4#	83.0	519	265	6#
16.5	223	125	2#	41.5	354	205	4#	84.0	519	265	6#
17.0	223	125	2#	42.0	354	205	4#	85.0	519	265	6#
17.25	228	130	2#	42.5	354	205	4#	86.0	524	270	6#
17.5	228	130	2#	43.0	359	210	4#	87.0	524	270	6#
18.0	228	130	2#	43.5	359	210	4#	88.0	524	270	6#
18.5	233	135	2#	44.0	359	210	4#	89.0	524	270	6#
19.0	233	135	2#	44.5	359	210	4#	90.0	524	270	6#
19.5	238	140	2#	45.0	359	210	4#	91.0	529	275	6#
20.0	238	140	2#	45.5	364	215	4#	92.0	529	275	6#
20.5	243	145	2#	46.0	364	215	4#	93.0	529	275	6#
21.0	243	145	2#	46.5	364	215	4#	94.0	529	275	6#
21.5	248	150	2#	47.0	364	215	4#	95.0	529	275	6#
22.0	248	150	2#	47.5	364	215	4#	96.0	534	280	6#
22.5	253	155	2#	48.0	369	220	4#	97.0	534	280	6#
23.0	253	155	2#	48.5	369	220	4#	98.0	534	280	6#
23.5	276	155	3#	49.0	369	220	4#	99.0	534	280	6#
24.0	281	160	3#	49.5	369	220	4#	100.0	534	280	6#

Hss Double End Twist Drill

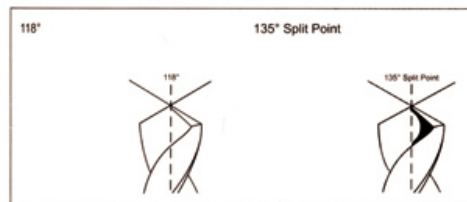

Surface Treatment

01-黑色/Black Oxide



02-白色/Bright Finish



03-镀钛/Bright Finish + Tin Coated

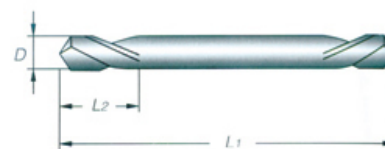

D	L1	L2	D	L1	L2
2.0	38.0	7.5	6.0	66.0	19.0
2.5	43.0	9.5	6.5	70.0	21.2
3.0	46.0	10.6	7.0	74.0	23.6
3.2	49.0	11.2	7.5	74.0	23.6
3.5	52.0	12.5	8.0	79.0	25.0
4.0	55.0	14.0	8.5	79.0	25.0
4.5	58.0	15.5	9.0	84.0	25.0
5.0	62.0	17.0	9.5	84.0	25.0
5.5	66.0	19.0	10.0	89.0	25.0

Hss Center Drills

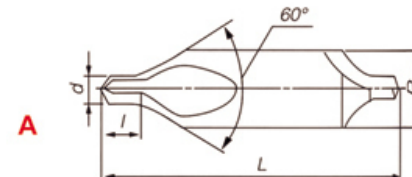

d	D	L	I
1.00	3.15	33.5	1.90
1.25	3.15	33.5	1.90
1.60	4.00	37.5	2.80
2.00	5.00	42.0	3.30
2.50	6.30	47.0	4.10
3.15	8.00	52.0	4.90
4.00	10.0	59.0	6.20
5.00	12.5	66.0	7.50
6.30	16.0	74.0	9.20

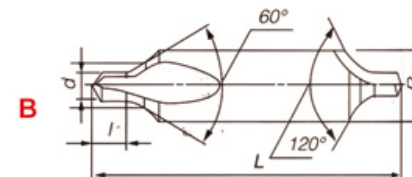

d	D	L	I
1.00	4.00	37.5	1.90
1.25	5.00	42.0	2.20
1.60	6.30	47.0	2.80
2.00	8.00	52.5	3.30
2.50	10.0	59.0	4.10
3.15	11.2	63.0	4.90
4.00	14.0	70.0	6.20
5.00	18.0	78.0	7.50
6.30	20.0	83.0	9.20

Glass Drill Bit



Diameter	Length
3	65
4	65
5	65
6	65
7	70
8	75
10	85
12	95
13	95
14	100
16	100
18	100



Diameter	Length
1/8	75
5/32	75
3/16	75
1/4	75
5/16	85
3/8	85
1/2	95
5/8	100

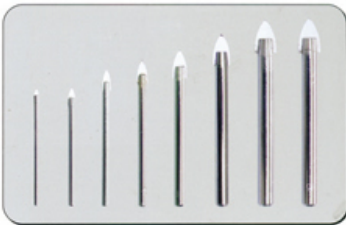

Hss 3-Flutes Taper & Deburring Countersinks



90°

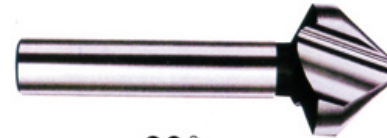

60°



75°



120°

Size	O.L.	Shank Size	Head Dia.
4.3	40mm	4mm	4.3mm
5.0	40mm	4mm	5.0mm
5.3	40mm	4mm	5.3mm
5.8	45mm	5mm	5.8mm
6.0	45mm	5mm	6.0mm
6.3	45mm	5mm	6.3mm
7.0	50mm	6mm	7.0mm
7.3	50mm	6mm	7.3mm
8.0	50mm	6mm	8.0mm
8.3	50mm	6mm	8.3mm
9.4	50mm	6mm	9.4mm
10.0	50mm	6mm	10.0mm
10.4	50mm	6mm	10.4mm
11.5	56mm	8mm	11.5mm
12.4	56mm	8mm	12.4mm
13.4	56mm	8mm	13.4mm
15.0	60mm	10mm	15.0mm
16.5	60mm	10mm	16.5mm
19.0	63mm	10mm	19.0mm
20.5	63mm	10mm	20.5mm
23.0	67mm	10mm	23.0mm
25.0	67mm	10mm	25.0mm
26.0	67mm	10mm	26.0mm
28.0	71mm	12mm	28.0mm
30.0	71mm	12mm	30.0mm
31.0	71mm	12mm	31.0mm
40.0	80mm	15mm	40.0mm

Hss Countersink & Deburring Tool With Hole



Screw Extractors



Size(mm): 4,4.5,6,4.7,6,11,14.5,16,19,24mm



A Size(mm): 4,4.5,6,4.7,6,11mm
B Size(mm): 4,4.5,6,4.7,6,11,14.5mm

Size	O.L.	Shank Size	Head Dia.
2-5mm	45mm	6mm	10mm
5-10mm	48mm	8mm	14mm
10-15mm	65mm	10mm	21mm
15-20mm	85mm	12mm	28mm
20-25mm	102mm	15mm	35mm
25-30mm	115mm	15mm	44mm
30-35mm	127mm	15mm	48mm
35-40mm	136mm	15mm	53mm
40-50mm	166mm	20mm	60mm

Hss Conical Drills



Size	O.L.	Shank Size	Size	O.L.	Shank Size
3-14mm	57mm	6mm	36-50mm	97mm	12mm
8-20mm	66mm	8mm	40-60mm	103mm	12mm
4-20mm	71mm	8mm	5-22.5mm	79mm	8mm
4-30mm	104mm	10mm	5-25.4mm	87mm	10mm
16-30mm	72mm	9mm	5-31mm	103mm	9mm
26-40mm	89mm	10mm			

Hss Step Drill

Hss Saw Drill / Wood Drill / Bi-Metal Hole Saw

Hss Step Drill With Round Shank Or Hex Shank

- 1. Straight Flute
- 2. Spiral Flute

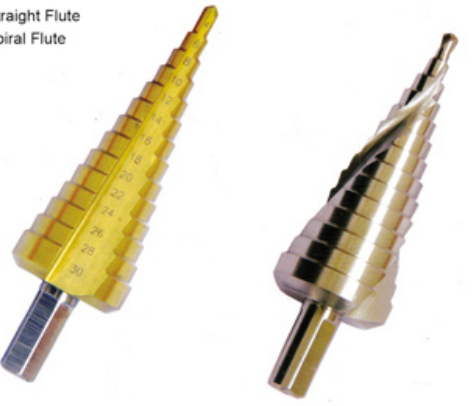

Size	O.L.	Steps	Shank Size
4-12mm	65mm	5	6
4-12mm	65mm	9	6
4-20mm	75mm	9	8
4-30mm	100mm	14	10
6-38mm	100mm	12	10
6-26.75mm	75mm	8	10
4-39mm	107mm	13	10
6-32mm	75mm	8	10
5-28mm	69mm	7	10
6-30.5mm	80mm	9	10
6-37mm	100mm	12	10
4.8-10.65mm	54mm	5	6
6-25mm	65mm	7	10
6-32mm	76mm	9	10
6-40mm	105mm	16	13
5.3-30.5mm	79mm	9	10
6.5-32.5mm	79mm	9	10
5.3-38.5mm	96mm	11	10
6.5-40.5mm	96mm	11	10

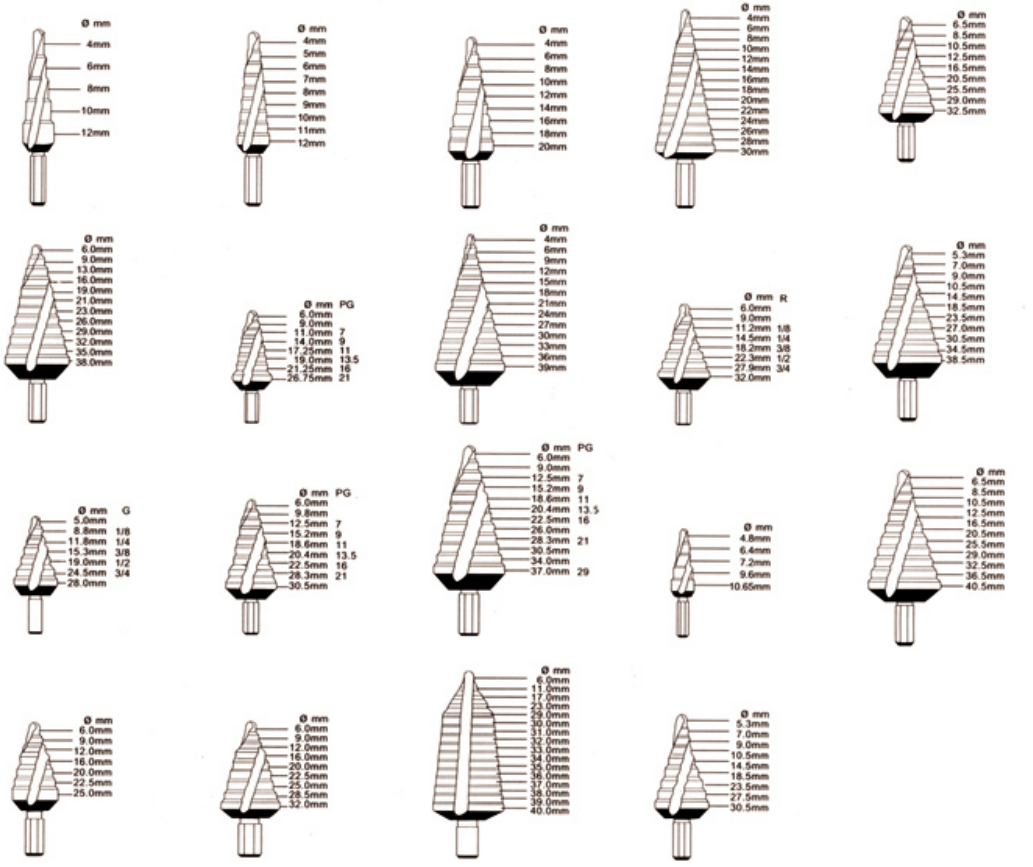

Hss Saw Drill With Round Shank Or Hex Shank

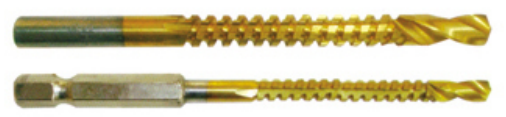

Size	O.L.	Flute Length
2.0	50	26
2.5	55	31
3.0	60	38
4.0	75	51
5.0	86	61
6.0	90	67
6.5	90	67
8.0	95	69
10.0	105	77

Wood Working Drill



Size	O.L.	Flute Length	Size	O.L.	Flute Length
3	60	32	10	120	82
4	75	43	11	140	90
5	85	51	12	140	90
6	92	54	13	150	95
7	100	60	14	150	95
8	115	71	15	160	100
9	115	71	16	160	100

Long Type: 200mm,300mm,400mm

Flat Wood Boring Bit



Size: 6, 8, 10, 12, 14, 16, 18, 20, 22, 24, 25, 26, 28, 30, 32, 34, 36, 38, 40mm
 Total Length: 150mm, 300mm, 400mm

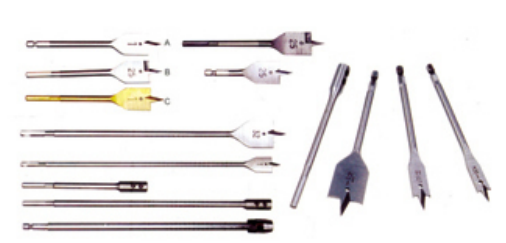

Auger Bit Lewis style with Sds-plus or Hex Shank



Size: 6, 8, 10, 13, 14, 15, 16, 17, 18, 19, 20, 21, 22, 24, 25, 26, 28, 30, 32, 34, 35, 36, 38, 40, 42, 44, 46, 48, 50, 53, 55, 58, 60mm
 Total Length: 4"(105mm), 5"(125mm), 6"(155mm), 8"(200mm), 9"(230mm), 10"(250mm), 12"(300mm), 16"(400mm), 18"(450mm), 20"(500mm), 24"(600mm)

Bi-Metal Holesaw



Metric	Inch	Metric	Inch	Metric	Inch
14mm	9/16"	44mm	1-3/4"	92mm	3-5/8"
16mm	5/8"	46mm	1-13/16"	95mm	3-3/4"
17mm	11/16"	48mm	1-7/8"	98mm	3-7/8"
19mm	3/4"	51mm	2"	102mm	4"
20mm	25/32"	52mm	2-1/16"	105mm	4-1/8"
21mm	13/16"	54mm	2-1/8"	108mm	4-1/4"
22mm	7/8"	57mm	2-1/4"	111mm	4-3/8"
24mm	15/16"	59mm	2-5/16"	114mm	4-1/2"
25mm	1"	60mm	2-3/8"	121mm	4-3/4"
27mm	1-1/16"	64mm	2-1/2"	127mm	5"
29mm	1-1/8"	65mm	2-9/16"	133mm	5-1/4"
30mm	1-3/16"	67mm	2-5/8"	140mm	5-1/2"
32mm	1-1/4"	68mm	2-11/16"	146mm	5-3/4"
33mm	1-5/16"	70mm	2-3/4"	152mm	6"
35mm	1-3/8"	73mm	2-7/8"	160mm	6-1/8"
37mm	1-7/16"	76mm	3"	165mm	6-1/2"
38mm	1-1/2"	79mm	3-1/8"	168mm	6-5/8"
40mm	1-9/16"	83mm	3-1/4"	177mm	6-31/32"
41mm	1-5/8"	86mm	3-3/8"	200mm	7-7/8"
43mm	1-11/16"	89mm	3-1/2"	210mm	8-17/64"





Diamond Core For Glass

D	d	S	L	D	d	S	L
3	3	/	50	38	10	30	55
4	4	/	50	40	10	30	55
5	5	/	50	42	10	30	55
6	6	/	50	45	10	30	55
8	6	30	50	48	10	30	55
10	6	30	50	50	10	30	55
12	6	30	50	53	10	30	55
14	6	30	50	55	10	30	55
15	6	30	50	60	10	30	55
16	6	30	50	65	10	30	55
18	6	30	50	70	10	30	55
20	8	30	55	75	10	30	55
22	8	30	55	80	10	30	55
23	8	30	55	85	10	30	55
24	8	30	55	90	10	30	55
25	8	30	55	95	10	30	55
26	8	30	55	100	10	30	55
28	8	30	55	105	12	30	55
30	8	30	55	110	12	30	55
32	8	30	55	120	12	30	55
35	8	30	55	125	12	30	55

Diamond Core Drill For Marble

D	d	S	L	D	d	S	L
8	6	35	55	45	10	35	65
10	6	35	55	50	10	35	65
12	6	35	55	55	10	35	65
14	6	35	55	60	10	35	65
15	6	35	55	65	10	35	65
16	6	35	55	70	10	35	65
18	8	35	65	75	10	35	65
20	8	35	65	80	10	35	65
22	8	35	65	85	10	35	65
25	8	35	65	90	10	35	65
28	8	35	65	95	10	35	65
30	10	35	65	100	10	35	65
32	10	35	65	105	12	35	65
35	10	35	65	110	12	35	65
38	10	35	65	120	12	35	65
40	10	35	65	125	12	35	65
42	10	35	65				

Masonry Drills-DIN8039

- Masonry Drills, Zinc Plated **M001**
- Masonry Drills, Black Oxide **M002**
- Masonry Drills, Nickel Plated **M003**
- Masonry Drills, Long Type **M004**
- Masonry Drills, Reduced Shank **M005**
- Masonry Drills, Super Quality Black & White **M006**
- Masonry Drills, Super Quality Tin-Coated **M007**
- Masonry Drills, high-helix, Chrome Plated **M008**
- Masonry Drills, high-helix, Nickel Plated **M009**
- Masonry Drills, high-helix, Zinc Plated **M010**
- Masonry Drills, Double Flutes **M011**
- Masonry Drills, Double Flutes **M012**
- Masonry Drills, Black & White **M013**
- Masonry Drills, high-helix **M014**

Masonry Drill

D(mm)	L	D(mm)	L	D(mm)	L
3	60	7	200	26	300
4	75	8	200	6	400
5	85	9	200	6.5	400
6	100	10	200	7	400
6.5	100	12	200	8	400
7	100	13	200	9	400
8	120	14	200	10	400
9	120	16	200	12	400
10	120	18	200	13	400
5	150	19	200	14	400
6	150	20	200	16	400
6.5	150	22	200	18	400
7	150	24	200	19	400
8	150	25	200	20	400
9	150	26	200	22	400
10	150	6	300	24	400
11	150	6.5	300	25	400
12	150	7	300	26	400
13	150	8	300	8	600
14	150	9	300	9	600
16	150	10	300	10	600
18	160	12	300	12	600
19	160	13	300	13	600
20	160	14	300	14	600
22	160	16	300	16	600
24	160	18	300	18	600
25	160	20	300	20	600
5	200	22	300	22	600
6	200	24	300	24	600
6.5	200	25	300	26	600

5Pcs Hss Twist Drill Set



- 1 black finished
- 2 edge ground
- 3 tin coated
- 4 fully ground bright
- 5 fully ground black
- 6 fully ground tin

Size(mm):
1.5,2.5,3,4,5mm

XS-H501

6Pcs Hss Twist Drill Set



- 1 black finished
- 2 edge ground
- 3 tin coated
- 4 fully ground bright
- 5 fully ground black
- 6 fully ground tin

Size(mm):
2,3,4,5,6,8mm

XS-H601 XS-H602

8Pcs Hss Twist Drill Set



- 1 black finished
- 2 edge ground
- 3 tin coated
- 4 fully ground bright
- 5 fully ground black
- 6 fully ground tin

Size(mm):
3,4,5,6,7,8,9,10mm

XS-H801 XS-H802

13Pcs Hss Twist Drill Set



- 1 black finished
- 2 edge ground
- 3 tin coated
- 4 fully ground bright
- 5 fully ground black
- 6 fully ground tin

Size(mm):
2-8x0.5mm

XS-H1310 XS-H1311

19Pcs Hss Twist Drill Set



- 1 black finished
- 2 edge ground
- 3 tin coated
- 4 fully ground bright
- 5 fully ground black
- 6 fully ground tin

Size(mm):
1-10x0.5mm

XS-H1901 XS-H1902

8Pcs Hss Twist Drill Set



- 1 black finished
- 2 edge ground
- 3 tin coated
- 4 fully ground bright
- 5 fully ground black
- 6 fully ground tin

Size(mm):
3,4,5,6,7,8,9,10mm

XS-H803

10Pcs Hss Twist Drill Set



- 1 black finished
- 2 edge ground
- 3 tin coated
- 4 fully ground bright
- 5 fully ground black
- 6 fully ground tin

Size(mm):
1,2,3,4,5,6,7,8,9,10mm

XS-H1001 XS-H1002 XS-H1003

19Pcs Hss Twist Drill Set



- 1 black finished
- 2 edge ground
- 3 tin coated
- 4 fully ground bright
- 5 fully ground black
- 6 fully ground tin

Size(mm):
1,1.5,2,2.5,3,3.5,4,4.5,5,5.5,6,6.5,7,7.5,8,8.5,9,9.5,10mm

XS-H1903 XS-H1904 XS-H1905 XS-H1906

13Pcs Hss Twist Drill Set



- 1 black finished
- 2 edge ground
- 3 tin coated
- 4 fully ground bright
- 5 fully ground black
- 6 fully ground tin

Size(mm):
1.5,2.2,5,3,3.2,3.5,4,4.5,4.8,5.5,5.6,6.5mm

XS-H1301 XS-H1302 XS-H1303 XS-H1304 XS-H1305

19Pcs Hss Twist Drill Set



- 1 black finished
- 2 edge ground
- 3 tin coated
- 4 fully ground bright
- 5 fully ground black
- 6 fully ground tin

Size(mm):
1,1.5,2,2.5,3,3.5,4,4.5,5,5.5,6,6.5,7,7.5,8,8.5,9,9.5,10mm

XS-H1907 XS-H1908 XS-H1909 XS-H1910

13Pcs Hss Twist Drill Set



- 1 black finished
- 2 edge ground
- 3 tin coated
- 4 fully ground bright
- 5 fully ground black
- 6 fully ground tin

Size(Inch):
1/16,5/64,3/32,7/64,1/8,9/64,5/32,11/64,3/16,13/64,7/32,15/64,1/4

XS-H1306 XS-H1307 XS-H1308

13Pcs Hss Twist Drill Set



- 1 black finished
- 2 edge ground
- 3 tin coated
- 4 fully ground bright
- 5 fully ground black
- 6 fully ground tin

Size(mm):
2,2.5,3,3.5,4,4.5,5,5.5,6,6.5,7,7.5,8

XS-H1309

21Pcs Hss Twist Drill Set



- 1 black finished
- 2 edge ground
- 3 tin coated
- 4 fully ground bright
- 5 fully ground black
- 6 fully ground tin

Size(Inch):
1/16,5/64,3/32,7/64,1/8,9/64,5/32,11/64,3/16,13/64,7/32,15/64,1/4,17/64,9/32,19/64,5/16,21/64,11/32,23/64,3/8

XS-H2101 XS-H2102 XS-H2103 XS-H2104

25Pcs Hss Twist Drill Set

- 1 black finished
 - 2 edge ground
 - 3 tin coated
 - 4 fully ground bright
 - 5 fully ground black
 - 6 fully ground tin
- Size(mm):
1-13x0.5mm



XS-H2501



XS-H2502



XS-H2503



XS-H2504

29Pcs Hss Twist Drill Set

- 1 black finished
 - 2 edge ground
 - 3 tin coated
 - 4 fully ground bright
 - 5 fully ground black
 - 6 fully ground tin
- Size(Inch):
1/16, 5/64, 3/32, 7/64, 1/8, 9/64,
5/32, 11/64, 3/16, 13/64, 7/32,
15/64, 1/4, 17/64, 9/32, 19/64,
5/16, 21/64, 11/32, 23/64, 3/8,
25/64, 13/32, 27/64, 7/16, 29/64,
15/32, 31/64, 1/2



XS-H2901



XS-H2902



XS-H2903

60Pcs Hss Twist Drill Set

- 1 black finished
 - 2 edge ground
 - 3 tin coated
 - 4 fully ground bright
 - 5 fully ground black
 - 6 fully ground tin
- Size(mm):
1-60x0.1mm

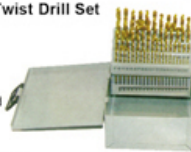

XS-H6001

115Pcs Hss Twist Drill Set

- 1 black finished
 - 2 edge ground
 - 3 tin coated
 - 4 fully ground bright
 - 5 fully ground black
 - 6 fully ground tin
- Size:
1/16-1/2
1-60, A-Z

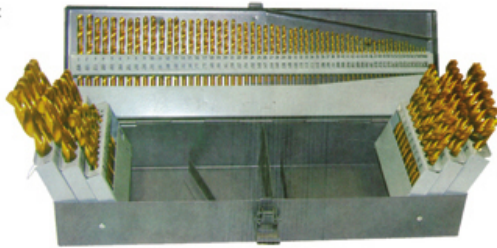

XS-H11501



XS-H11502

170Pcs Hss Twist Drill Set

- 1 black finished
 - 2 edge ground
 - 3 tin coated
 - 4 fully ground bright
 - 5 fully ground black
 - 6 fully ground tin
- Size(mm):
1.0-8.0x0.5mmx10pcs
8.5-10.0x0.5mmx5pcs



XS-H17001

230Pcs Hss Twist Drill Set

- 1 black finished
 - 2 edge ground
 - 3 tin coated
 - 4 fully ground bright
 - 5 fully ground black
 - 6 fully ground tin
- Size(mm):
1.0-1.5x20pcs
2.0-8.0x0.5mmx10pcs
8.5-13.0x0.5mmx5pcs



XS-H23001

3Pcs Masonry Drill Set

- 1.Zink plated
 - 2.Nickle plated
 - 3.Chrom plated
 - 4.Black & White
 - 5.Sand Blasting(Grey)
- Size(mm):
8,10,12x200,300,400,600mm
10,12,14x200,300,400,600mm
12,14,16x200,300,400,600mm



XS-M301

4Pcs Masonry Drill Set

- 1.Zink plated
 - 2.Nickle plated
 - 3.Chrom plated
 - 4.Black & White
 - 5.Sand Blasting(Grey)
- Size1(mm): 4,5,6,8mm
Size2(mm): 5,6,8,10mm



XS-M401



XS-M402



XS-M403

5Pcs Masonry Drill Set

- 1.Zink plated
 - 2.Nickle plated
 - 3.Chrom plated
 - 4.Black & White
 - 5.Sand Blasting(Grey)
- Size(mm): 4,5,6,8,10mm



XS-M501



XS-M502



XS-M503



XS-M504

8Pcs Masonry Drill Set

- 1.Zink plated
 - 2.Nickle plated
 - 3.Chrom plated
 - 4.Black & White
 - 5.Sand Blasting(Grey)
- Size(mm): 3,4,5,6,7,8,9,10mm



XS-M801



XS-M802



XS-M803

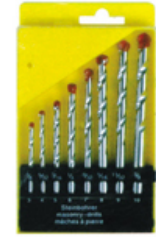

XS-M804

5Pcs Wood Drill Set

- 1.Black & White
 - 2.edge ground
 - 3.tin coated
- Size(mm): 4,5,6,8,10mm



XS-W501



XS-W502

8Pcs Wood Drill Set

- 1.Black & White
 - 2.edge ground
 - 3.tin coated
- Size(mm): 3,4,5,6,7,8,9,10mm



XS-W801



XS-W802

9Pcs Combination Drill Set

- 1. Hss Twist Drills: 5,6,8mm
Masonry Drills: 5,6,8mm
Wood Working Drills: 5,6,8mm
- 2. Hss Twist Drills: 3,4,5,6,8mm
Masonry Drills: 4,5,6,8mm



XS-C901



XS-C902



XS-C903



XS-C904

15Pcs Combination Drill Set

- Hss Twist Drills: 4,5,6,8,10mm
- Masonry Drills: 4,5,6,8,10mm
- Wood Working Drills: 4,5,6,8,10mm



XS-C1501



XS-C1502

16Pcs Combination Drill Set

- Hss Twist Drills: 2,3,4,5,6,8mm
- Masonry Drills: 4,5,6,8,10mm
- Wood Working Drills: 4,5,6,8,10mm



XS-C1601

16Pcs Combination Drill Set

- Hss Twist Drills: 2,3,4,5,6,8mm
- Masonry Drills: 4,5,6,8,10mm
- Wood Working Drills: 4,5,6,8,10mm



XS-C1602

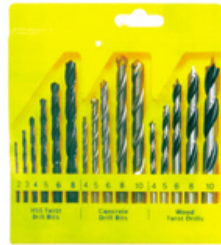

XS-C1603



XS-C1604

5Pcs Wood Forstner Bit Set

- Size(mm): 15,20,25,30,35mm



XS-F501

Hss Saw Drill Set

- 1. 4Pcs Set
Size(mm): 3,5,6,5,8mm
- 2. 6Pcs Set
Size(mm): 3,4,5,6,6,5,8mm
- 3. 7Pcs Set(Hex Shank)
Size(mm): 3,3,5,4,5,6,6,5,8mm



XS-S301



XS-S601



XS-S701



Hss Square Tool Bits

Size(mm): 3,4,5,6,8,10,12,14,16,18,20,22,25,28,30mm

Length(mm): 100,150,200mm

Inch: 1/4x2-1/2", 1/4x3", 1/4x4", 1/4x5", 1/4x6", 1/4x8", 5/16x3", 5/16x4", 5/16x5", 5/16x6", 5/16x8", 3/8x3", 3/8x4", 3/8x5", 3/8x6", 3/8x8", 1/2x4", 1/2x6", 1/2x8", 3/4x4", 3/4x6", 3/4x8", 1"x4", 1"x6", 1"x8".

Hss Rectangular Tool Bits

Size(mm): 3x8x100(150,200mm); 5x8x100(150,200mm);
6x8x100(150,200mm); 3x10x100(150,200mm);
5x10x100(150,200mm); 6x10x100(150,200mm);
8x10x100(150,200mm); 5x12x100(150,200mm);
8x12x100(150,200mm); 5x16x100(150,200mm);
6x16x100(150,200mm); 8x16x100(150,200mm);
12x16x100(150,200mm); 6x20x100(150,200mm);
8x20x100(150,200mm); 10x20x100(150,200mm);
12x20x100(150,200mm); 16x20x100(150,200mm).

Hss Round Tool Bits

Size(mm): 1,2,3,4,5,6,7,8,9,10,11,12,13,14,15,16,18,20mm

Length(mm): 100,150,200mm

Inch: 1/8", 3/16", 1/4", 5/16", 3/8", 1/2", 5/8", 3/4", 1".

Length(Inch): 4", 6", 8"

Hss T-type Ladder Tool Bits

Size(mm): 2x3x8x150(200mm); 3x4x8x150(200mm);
4x5x8x150(200mm); 5x6x8x150(200mm);
2x3x20x150(200mm); 3x4x20x150(200mm);
4x5x20x150(200mm).

Inch: 1/8"x3/16"x3/4"x6"(8"),
5/16"x3/8"x1"x6"(8"),
5/16"x3/8"x3/4"x6"(8")



6pcs Hss Countersink 90° Three Flute Drill With Round Shank Set



6pcs Hss Countersink 90° Three Flute Drill With Hex Shank Set



6pcs Hss Step Drill Set



6pcs Hss Step Drill Set



3pcs Hss Conical Drill Set



Plane Type Adjustable Drill



4pcs Hole Countersink Drill Set



5pcs 1/2" Shank Hss Drill Set



HAMMER DRILLS

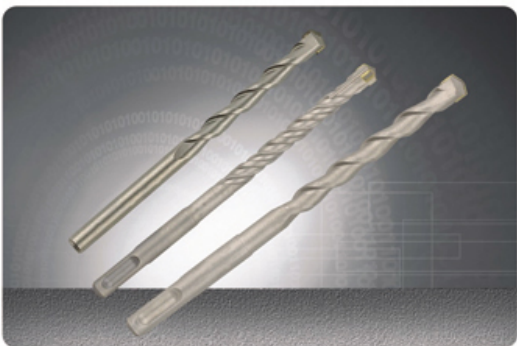

Employing high quality alloy steel for drilling body and tungsten carbide for drilling tip, and in combination with various types of electric hammer. The drills are one of the most efficient tools suitably and widely used for hole drilling in hard materials like concrete/brick in construction & installation industries. Available in sandblast, bright finish, black oxide, brown color etc.

CHISELS

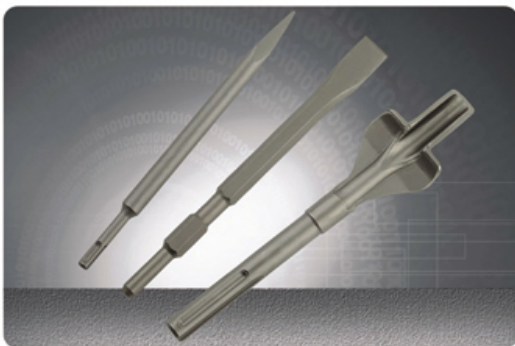

The chisel can be used with electric hammer and it is widely applicable and high efficient chiselling hole, cutting groove tool for concrete and brick wall. Our products include pointed chisel, big flat chisel, gouge and groove chisel. The chisel length can be selected according to customers' requirements. The shank types can be selected according to upper list of shank structure.

HAMMER DRILL SETS

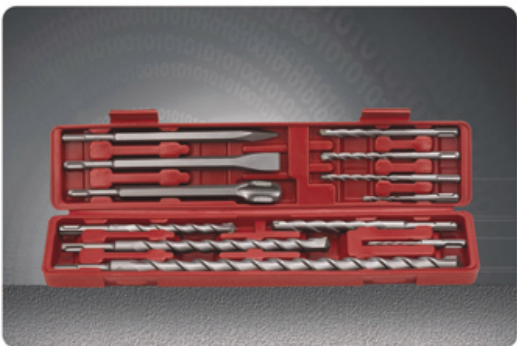

High quality alloy steel 40Cr for drilling body and tungsten carbide tip YG8C for drilling tip, drill bits can be combined with various types and different number as per the customers' requirements. The package have aluminum case, wooden case and blow-molded case and so on.

HOLLOW HAMMER DRILLS



With hollow core, connecting rod and pilot drill combined, hollow hammer drill is one of most efficient tools suitable and widely used for hole drilling in hard material like concrete or brick in construction and installation industries. The size and shank structure can be selected according to demands.

Standard Flute XS-plus Shank Hammer Drills



XSSDS01

Double Flutes XS-plus Shank Hammer Drills



XSSDS02

Cross-Head "+" Double-Flutes XS-plus Shank Hammer Drills



XSSDS03

Three Cutting Edges Three Flutes XS-plus Shank Hammer Drills



XSSDS04

D	L	D	L	D	L
4	110	10	310	10	600
5	110	12	310	12	600
6	110	14	310	14	600
8	110	16	310	16	600
10	110	18	310	18	600
12	110	20	310	20	600
4	160	22	310	22	600
5	160	25	310	25	600
6	160	8	350	26	600
8	160	10	350	28	600
10	160	12	350	30	600
12	160	14	350	32	600
14	160	16	350	10	800
16	160	18	350	12	800
6	210	20	350	14	800
8	210	22	350	16	800
10	210	25	350	18	800
12	210	8	400	20	800
13	210	10	400	22	800
14	210	12	400	25	800
16	210	14	400	26	800
18	210	16	400	28	800
20	210	18	400	30	800
22	210	20	400	32	800
25	210	22	400	10	1000
6	260	25	400	12	1000
8	260	28	400	14	1000
10	260	30	400	16	1000
12	260	32	400	18	1000
14	260	8	460	20	1000
16	260	10	460	22	1000
18	260	12	460	25	1000
20	260	14	460	26	1000
22	260	16	460	28	1000
25	260	18	460	30	1000
26	260	20	460	32	1000
6	310	22	460		
8	310	25	460		

XS-Max Shank Electric Hammer Drills Cross-Head XS-Max Shank Electric Hammer Drills



XSMAX05



XSMAX06

D	L	D	L	D	L
10	280	30	400	18	600
12	280	32	400	20	600
14	280	35	400	22	600
16	280	38	400	25	600
18	280	40	400	28	600
20	280	10	460	30	600
22	280	12	460	32	600
25	280	14	460	35	600
28	280	16	460	38	600
30	280	18	460	40	600
32	280	20	460	42	600
35	280	22	460	45	600
38	280	25	460	20	800
10	340	30	460	22	800
12	340	40	460	25	800
14	340	10	505	28	800
16	340	12	505	30	800
18	340	14	505	32	800
20	340	16	505	35	800
22	340	18	505	38	800
25	340	20	505	40	800
28	340	22	505	20	1000
30	340	25	505	22	1000
32	340	28	505	25	1000
35	340	30	505	28	1000
38	340	32	505	30	1000
10	400	35	505	32	1000
12	400	38	505	35	1000
14	400	40	505	38	1000
16	400	42	505	40	1000
18	400	45	505	42	1000
20	400	10	600	45	1000
22	400	12	600		
25	400	14	600		
28	400	16	600		

Spline Shank Electric Hammer Drills



XSSPLINE07

D	L	D	L	D	L
12	280	25	505	22	505
14	280	28	505	25	505
16	280	30	505	30	505
18	280	14	505	32	505
20	280	16	505	35	505
22	280	18	505	20	600
24	280	20	505	35	600

XS-PLUS Shank Hexagonal Body Hammer Drills



XSSDS08

D	L	D	L	D	L
5.8	160	6	210	7	260
6	160	6.5	210	7.5	260
6.5	160	7	210	8	260
7	160	7.5	210	7	310
7.5	160	8	210	7.5	310
8	160	6	260	8	310
5.8	210	6.5	260		

Hexagon Shank Electric Hammer Drills



XSHEX09

D	L	D	L	D	L
10	280	20	400	22	800
12	280	22	400	25	800
14	280	25	400	28	800
16	280	28	400	30	800
18	280	30	400	22	1000
20	280	20	600	25	1000
12	400	22	600	28	1000
14	400	25	600	30	1000
16	400	28	600	32	1000
18	400	30	600		

Hollow Electric Hammer Drill



(D:Φ30, Φ35, Φ40, Φ45, Φ50, Φ55, Φ60, Φ65, Φ68, Φ70, Φ75, Φ80, Φ82, Φ85, Φ90, Φ95, Φ100, Φ105, Φ110, Φ115, Φ120, Φ125, Φ150, Φ170mm)

六角柄连接杆 Hex Shank

(L:90,100,110,120mm)



五坑柄连接杆 XS-Max Shank

(L:160,200,250,300,350,450,500,600mm)



元柄连接杆 XS-Plus Shank

(L:110,160,200,250,300,350,450,500,600mm)



长六角柄连接杆 Hex Shank Mode II

(L:160,200,250,300,350,450,500,600mm)



Hollow Hammer Core Bit Set



XSH6502

Φ65mm Hollow Core Drill Bit
接杆 SDS SHANK 100mm



SXH8002

Φ80mm Hollow Core Drill Bit
接杆 SDS SHANK 100mm



SXH6580

Φ65mm Φ80mm Hollow Core Drill Bit
接杆 SDS SHANK 100mm (2pcs)

XS-plus Shank Drill Chuck With Locking Screw



XSA16

XS-plus Shank Drill Chuck With 1/2"-20UNF thread



XSA17

XS-plus to XS-MAX Adapter

XSA18



XS-plus to XS-MAKITA Adapter

XSA19



XS-plus to XS-KANGO Adapter

XSA20



Adapter



Adapter



Adapter



Adapter



Chisels



XSC01 XS-plus shank pointed chisel



XSC02 XS-plus shank small flat chisel



XSC03 XS-plus shank spade chisel



XSC04 XS-plus shank Butterfly chisel



XSC05 XS-plus shank hexagon body pointed chisel



XSC06 XS-plus shank hexagon body spade chisel



XSC07 XS-plus shank hexagon body Groove chisel



XSC08 Hexagon shank pointed chisel for Makita & Hitachi



XSC09 Hexagon shank small flat chisel for Makita & Hitachi

13mm Makita Hexagonal Shank to SDS Plus Drill Chuck Adapter
19 mm Spline shank to sds plus Drill Chuck Adapter
Wide flat chisel 75x280 for 17 mm Makita hexagonal shank
Wide flat chisel 50x280 for 17 mm Makita hexagonal shank

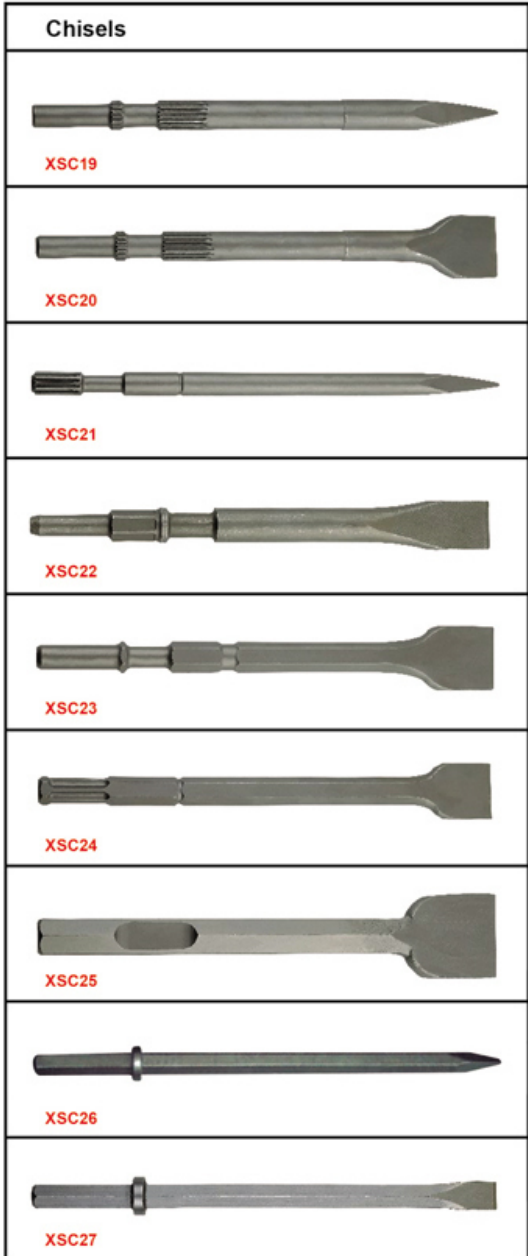
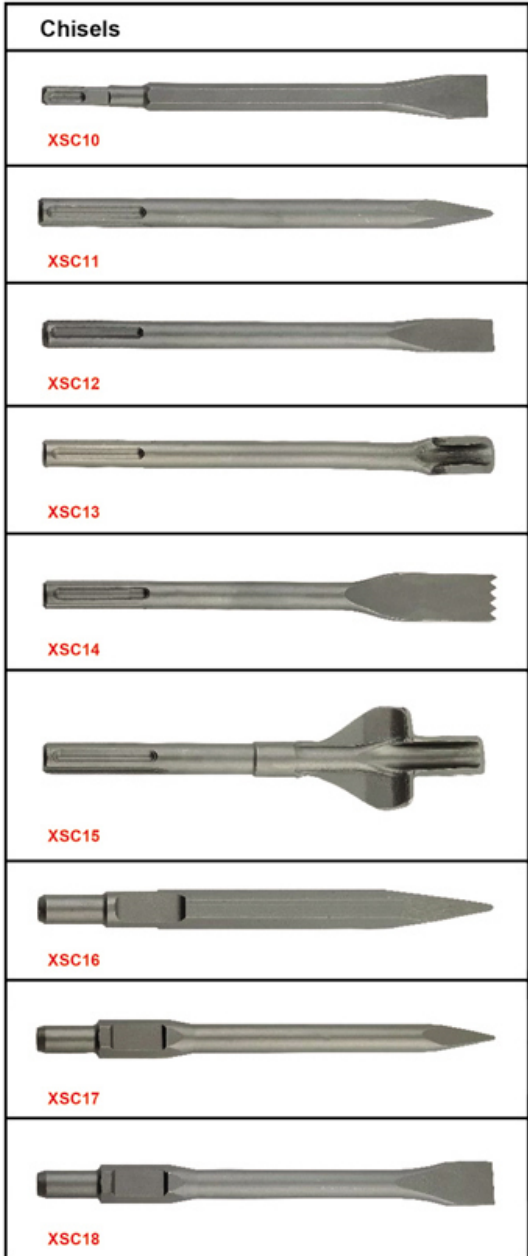

SDS MAX Chisel with Curved Head
 SDS PLUS Chisel with Curved Head
 HITACHI Hex shank Chisels (PH65) flat 30x400mm Point 30x400mm

3pcs Hammer Drill Bit Set
 XSSDS301: 5,6,8x110mm
 XSSDS302: 5,6x110mm 8x160mm
 XSSDS303: 5x110mm 6,8x160mm



XSSDS301 XSSDS302 XSSDS303

4pcs Hammer Drill Bit Set
 XSSDS401: 5,6x110mm 8,10x160mm
 XSSDS402: 5,6,8,10x160mm



XSSDS401 XSSDS402

5pcs Hammer Drill Bit Set
 XSSDS501: 5,6,8,10,12x160mm
 XSSDS502: 5,6,8x110mm 10,12x160mm



XSSDS501 XSSDS502

6pcs Hammer Drill Bit Set
 XSSDS601: 10,12,14,16,18,20x450mm



XSSDS601

6pcs Hammer Drill Bit Set
 XSSDS602 / XSSDS603
 6,8,10x110mm 6,8,10x160mm



XSSDS602 XSSDS603

7pcs Hammer Drill Bit Set
 XSSDS701 / XSSDS702
 5,6,8x110mm 6,8,10,12x160mm



XSSDS701 XSSDS702

7pcs Hammer Drill Bit Set
 XSSDS703: 6x160mm(3PCS)
 8x160mm(3PCS) 10x160mm



XSSDS703

8pcs Hammer Drill Bit Set
 XSSDS801: 5,6,8,10x110mm
 5,6,8,10x160mm



XSSDS801

8pcs Hammer Drill Bit Set
 XSSDS802: 5,6,8x110mm 8x210mm
 6,8,10,12x160mm



XSSDS802

10pcs Hammer Drill Bit Set
 XSSDS1001: 5,6,8x110mm 10,12x160mm
 14,16x210mm 20x400mm
 Point Chisel: 14x250mm
 Flat Chisel: 14x250x40mm



XSSDS1001

11pcs Hammer Drill Bit Set
 XSSDS1101 / XSSDS1102 / XSSDS1103
 5,6x110mm 6,8,10x150mm 10,12x210mm
 10,12,16,20x450mm



XSSDS1101

11pcs Hammer Drill Bit Set
 XSSDS1102 / XSSDS1103



XSSDS1102
 XSSDS1103

12pcs Hammer Drill Bit Set
 XSSDS1201: 5,6x110mm 8,10,12x160mm
 14x210mm 16x210mm
 18x310mm 20x450mm
 Point Chisel: 14x250mm
 Flat Chisel: 14x250x20mm
 Groove Chisel: 14x250mm



XSSDS1201

12pcs Hammer Drill Bit Set
 XSSDS1202: 5,6x110mm 6,8,10x160mm
 10,12x210mm 10,12,16x450mm
 Point Chisel: 14x250mm
 Flat Chisel: 14x250x20mm



XSSDS1202

14pcs Hammer Drill Bit Set
 XSSDS1401: 5x110mm 6,8,10x160mm
 8,10,12x210mm 10,12,14x260mm
 Point Chisel: 14x250mm
 Flat Chisel: 14x250x20mm
 14x250x40mm
 Groove Chisel: 14x250mm



XSSDS1401

13pcs Hammer Drill Bit Set
 XSSDS1301: 6,8,10x160mm 8,10,12x210mm 10,12,14x260mm
 尖(point chisel): 14x250mm 半圆钩(groove chisel): 14x250mm
 扁(flat chisel): 14x250x20mm 14x250x40mm



XSSDS1301 **XSSDS1302**

17pcs Hammer Drill Bit Set
 XSSDS1701: 5,6,8,10x110mm 6,8,10,12x160mm
 8,10x210mm 12,14x260mm
 尖(point chisel): 14x140mm 14x250mm
 扁(flat chisel): 14x140x20mm 14x250x20mm 14x250x40mm



XSSDS1701

17pcs Hammer Drill Bit Set
 XSSDS1702: 5,5,6x110mm
 5,5,5,6,6,5,7,8,10x160mm
 14x210mm 10,12,16x260mm
 尖(point chisel): 14x250mm
 小扁(flat chisel): 14x250x20mm(2pcs)
 扁(flat chisel): 14x250x20mm 14x250x40mm



XSSDS1702

19pcs Hammer Drill Bit Set
 XSSDS1901: 8,8,10,10x160mm
 10,12,13,14,16,16x210mm
 16,20,25x450mm
 尖(point chisel): 14x250mm(3pcs)
 小扁(flat chisel): 14x250x20mm(2pcs)
 半圆钩(groove chisel): 14x250mm



XSSDS1901

19pcs Hammer Drill Bit Set
 XSSDS1902: 5,5,5,6,6,5,7,7x160mm(2pcs)
 12,14,16x210mm 10,18,25x450mm
 尖(point chisel): 14x250mm
 扁(flat chisel): 14x250x20mm 14x250x40mm



XSSDS1902

20pcs Hammer Drill Bit Set
 XSSDS2001: 5,6,8x110mm
 6,6,8,8,10,10,12x160mm
 8,10,12,14x210mm
 14,16x260mm
 10,12,16,20x450mm



XSSDS2001

37pcs Hammer Drill Bit Set
 XSSDS3701: 6,8,10x160mm(3pcs)
 8,10,12x210mm(3pcs)
 8,10,12,14x260mm(3pcs)
 10,12,14x310mm
 尖(point chisel): 14x250mm
 半圆钩(groove chisel): 14x250mm
 扁(flat chisel): 14x250x20mm 14x250x40mm



XSSDS3701

50pcs Hammer Drill Bit Set
 XSSDS5001: 5x110mm(10pcs) 6x110mm(10pcs)
 6x160mm(5pcs) 8x160mm(5pcs)
 10x160mm(5pcs) 8x210mm(5pcs)
 10x210mm(5pcs) 12x210mm(5pcs)



XSSDS5001

Extension TCT Hole Saw
 加长型合金开孔器



Size(mm):15,16,17,18,19,20,21,22,23,24,25,26,28,30,32,35,38,40,42,45,48,50,53,55,60,63,65,68,70,75,80,85,90,100mm

Carbide Tipped Hole Saw
 合金开孔器



Size(mm):15,16,17,18,19,20,21,22,23,24,25,26,28,30,32,35,38,40,42,45,48,50,53,55,60,63,65,70,75,80,85,90,100mm

5Pcs Plug Cutters Set



Size(mm):15,20,25,30,35mm

11Pcs Hole Saw Set
 Hole Saw:19,25,29,32,38,44,51,64mm
 1pc Allen Key 1pc Adapter
 1pc Adapter with Arbor Drill



TCT Forstner Bit
 合金木工平翼钻



Size(mm):15,16,17,18,19,20,21,22,23,24,25,26,28,30,32,35,38,40,42,45,48,50,53,55,60,63,65,68,70,75,80,85,90,100mm

Hss Hole Saw
 高速钢开孔器



Size(mm):15,16,17,18,19,20,21,22,23,24,25,26,28,30,32,35,38,40,42,45,48,50,53,55,60,63,65,70,75,80mm

16Pcs Hole Saw Set
 Hole Saw:19,22,29,32,38,44,51,64,75,80,100,127mm
 1pc Allen Key 1pc Adapter
 1pc Adapter with Arbor Drill
 1pc Filing Plate



7pcs Woodworking Countersink Set



Wood Forstner Bit
 木工平翼钻



Size(mm):10,12,14,15,16,17,18,19,20,21,22,23,24,25,26,28,30,32,35,38,40,42,45,48,50,53,55,60,63,65,68,70,75,80,85,90,100mm

Woodworking Countersink
 木工倒角器



Size(Inch):3/32,7/64,1/8,9/64,5/32,11/64,3/16,13/64,7/32,1/4,9/32,5/16,21/64,3/8

Auger Bit Set



1.6pcs Auger Bit Set(6,8,10,12,16,20mmx230mm)
 2.6pcs Auger Bit Set(10,12,14,16,18,20mmx300,300,450mm)
 3.6pcs Auger Bit Set(6,8,10,12,14,16,18,20mmx200mm)
 4.6pcs Auger Bit Set(10,12,14,16,18,20,22,24mmx480mm)

13Pcs Hole Saw Set
 Hole Saw:19,22,25,29,32,38,44,51,64mm
 1pc Allen Key 1pc Adapter
 1pc Adapter with Arbor Drill
 1pc 22mm Flat Drill Bit



Carpenter Hemisphere-Type Wimble
 球形门锁开孔器



Size(mm):22mm(7/8")
 54mm(2-1/8")

Adjustable Woodworking Hole Saw
 飞机型可调节开孔器



Size(mm):30-120mm
 40-200mm
 40-300mm

15Pcs Wood Forstner Bit Set



Size(mm):10,12,15,16,18,20,22,25,26,28,30,35,40,45,50mm

100Pcs Power Screwdriver Bits



Cold Pressed Segmented Dry Blade-General Purpose

适用于花岗岩, 大理石, 混凝土, 砖块
等各种材料的切割

Applying to various material
cutting granite,marble,concrete,
brick.



MM	Inch	Height	Bore
105	4"	7/10	20
115	4.5"	7/10	22.2
125	5"	7/10	22.2
150	6"	7/10	22.2
180	7"	7/10	22.2
200	8"	7/10	22.2/25.4
230	9"	7/10	22.2/25.4
250	10"	7/10	22.2/25.4
300	12"	7/10	22.2/25.4
350	14"	7/10	22.2/25.4

Cold Pressed Segmented Type With Slot

适用于花岗岩, 大理石, 混凝土, 砖块
等各种材料的切割

Applying to various material
cutting granite,marble,concrete,
brick.

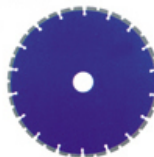

MM	Inch	Height	Bore
105	4"	7/10	20
115	4.5"	7/10	22.2
125	5"	7/10	22.2
150	6"	7/10	22.2
180	7"	7/10	22.2
200	8"	7/10	22.2/25.4
230	9"	7/10	22.2/25.4
250	10"	7/10	22.2/25.4
300	12"	7/10	22.2/25.4
350	14"	7/10	22.2/25.4

Cold Pressed Wet Blade

适用于花岗岩, 大理石, 陶瓷等
各种材料的切割

Applying to various material
cutting granite,marble,ceranics.



MM	Inch	Thickness	Height	Bore
105	4"	1.4	5/7/10	20
115	4.5"	1.4	5/7/10	22.2
125	5"	1.6	5/7/10	22.2
150	6"	1.6	5/7/10	22.2
180	7"	1.8	5/7/10	22.2
200	8"	2.0	5/7/10	22.2/25.4
230	9"	2.2	5/7/10	22.2/25.4
250	10"	2.4	5/7/10	22.2/25.4
300	12"	2.4	5/7/10	22.2/25.4
350	14"	2.4	5/7/10	22.2/25.4

Cold Pressed Segmented Turbo With Oblique Teeth

适用于花岗岩, 大理石, 陶瓷等
各种材料的切割

Applying to various material
cutting granite,marble,ceranics,
brick.

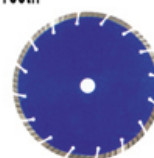

MM	Inch	Height	Bore
105	4"	7/10	20
115	4.5"	7/10	22.2
125	5"	7/10	22.2
150	6"	7/10	22.2
180	7"	7/10	22.2
200	8"	7/10	22.2/25.4
230	9"	7/10	22.2/25.4
250	10"	7/10	22.2/25.4
300	12"	7/10	22.2/25.4
350	14"	7/10	22.2/25.4

Cold Pressed Turbo Blade

适用于花岗岩, 混凝土等各种材料
的切割

Applying to various material
cutting granite,concrete.



MM	Inch	Height	Bore
105	4"	7/10	20
115	4.5"	7/10	22.2
125	5"	7/10	22.2
150	6"	7/10	22.2
180	7"	7/10	22.2
200	8"	7/10	22.2/25.4
230	9"	7/10	22.2/25.4
250	10"	7/10	22.2/25.4
300	12"	7/10	22.2/25.4
350	14"	7/10	22.2/25.4

Cold Pressed Segmented Turbo With Small Teeth

适用于花岗岩, 混凝土等各种材料
的切割

Applying to various material
cutting granite,concrete.



MM	Inch	Height	Bore
105	4"	10	20
115	4.5"	10	22.2
125	5"	10	22.2
150	6"	10	22.2
180	7"	10	22.2
200	8"	10	22.2/25.4
230	9"	10	22.2/25.4
250	10"	10	22.2/25.4
300	12"	10	22.2/25.4
350	14"	10	22.2/25.4

Tuck Point Normal Type

Features:
designed for cutting out mortar joints and
expansion joints in concrete and masonry
restoration.Making grooves on the surface
of construction materials.Fast and smooth
cutting granite,concrete and brick.



MM	Inch	Thickness	Height	Bore
105	4"	6.4/8/10	8/10	20
115	4.5"	6.4/8/10	8/10	22.2
125	5"	6.4/8/10	8/10	22.2
150	6"	6.4/8/10	8/10	22.2
180	7"	6.4/8/10	8/10	22.2
230	9"	6.4/8/10	8/10	22.2

Tuck Point V Type

Features:
special V-shaped segments are ideal for
smooth grooving in repairing the concrete
cracks and joints of construction building.

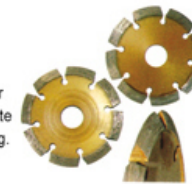

MM	Inch	Thickness	Height	Bore
90	3.5"	10	10	20/M10
100	4"	10	10	20/M10
105	4"	10	10	20/M10
125	5"	10	10	22.23/M10

Tuck Point U Type

Features:
special U-shape segments are ideal for
smooth grooving in repairing the concrete
cracks and joints of construction building.

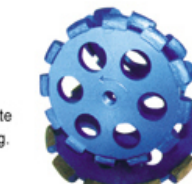

MM	Inch	Thickness	Height	Bore
90	3.5"	10	10	20/M10
100	4"	10	10	20/M10
105	4"	10	10	20/M10
125	5"	10	10	22.23/M10

Sintered Curve Cutting Thick Type

适用花岗岩, 大理石, 混凝土, 砖块
等各种材料的切割

Features:
specially designed for curve cutting,sintered
blades,best economic choice for curve
cutting porcelain,ceramic

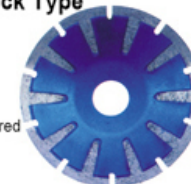

MM	Inch	Thickness	Bore
105	4"	8	20
125	5"	8	22.2
150	6"	8	22.2
180	7"	8	22.2

Sintered Curve Cutting Thin Type

适用花岗岩, 大理石, 陶瓷等
各种材料的切割

Applying to various material
grinding granite,concrete,brick.

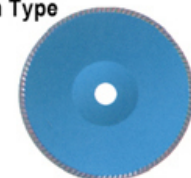

MM	Inch	Height	Bore
105	4"	8	20
115	4.5"	8	22.23
125	5"	8	22.2
150	6"	8	22.2
180	7"	8	22.2
230	9"	8	22.2



Cup Wheel Single Row 单排磨轮

适用于花岗岩, 混凝土, 砖块等
各种材料的磨削
Applying to various material
grinding granite, concrete, brick.



MM	Inch	Thickness	Bore
105	4"	5.0/6.0	20/M14/5/8" -11
115	4.5"	5.0/6.0	22.2/M14/5/8" -11
125	5"	5.0/6.0	22.2/M14/5/8" -11
150	6"	5.0/6.0	22.2/M14/5/8" -11
180	7"	5.0/6.0	22.2/M14/5/8" -11

Cup Wheel Double Row 双排磨轮

适用于花岗岩, 混凝土, 砖块等
各种材料的磨削
Applying to various material
grinding granite, concrete, brick.

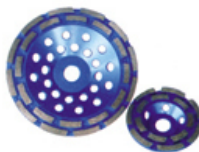

MM	Inch	Thickness	Bore
105	4"	5.0/6.0	20/M14/5/8" -11
115	4.5"	5.0/6.0	22.2/M14/5/8" -11
125	5"	5.0/6.0	22.2/M14/5/8" -11
150	6"	5.0/6.0	22.2/M14/5/8" -11
180	7"	5.0/6.0	22.2/M14/5/8" -11

Cup Wheel Straight Teeth Turbo 直齿波磨

适用于花岗岩, 混凝土等各种
材料的磨削
Applying to various material
grinding granite, concrete.



MM	Inch	Thickness	Height	Bore
105	4"	7	20	20/M14/5/8" -11
115	4.5"	7	20	22.2/M14/5/8" -11
125	5"	7	20	22.2/M14/5/8" -11
150	6"	7	20	22.2/M14/5/8" -11
180	7"	7	20	22.2/M14/5/8" -11

Cup Wheel 弧形波磨

适用于花岗岩, 混凝土, 砖块等
各种材料的磨削
Applying to various material
grinding granite, concrete, brick.



MM	Inch	Thickness	Height	Bore
105	4"	5	15/20	20/M14/5/8" -11
115	4.5"	5	15/20	22.2/M14/5/8" -11
125	5"	5	15/20	22.2/M14/5/8" -11
150	6"	5	20	22.2/M14/5/8" -11
180	7"	5	20	22.2/M14/5/8" -11

Cup Wheel With T Type Teeth T型齿磨轮

适用于花岗岩, 混凝土, 砖块等
各种材料的磨削
Applying to various material
grinding granite, concrete, brick.



MM	Inch	Thickness	Bore
105	4"	5.0	20/M14/5/8" -11
115	4.5"	5.0	22.2/M14/5/8" -11
125	5"	5.0	22.2/M14/5/8" -11
150	6"	5.0	22.2/M14/5/8" -11
180	7"	5.0	22.2/M14/5/8" -11

Cup Wheel Single Segment 单式磨轮

适用于花岗岩, 混凝土, 砖块等
各种材料的磨削
Applying to various material
grinding granite, concrete, brick.



MM	Inch	Thickness	Bore
105	4"	5.0	20/M14/5/8" -11
115	4.5"	5.0	22.2/M14/5/8" -11
125	5"	5.0	22.2/M14/5/8" -11
150	6"	5.0	22.2/M14/5/8" -11
180	7"	5.0	22.2/M14/5/8" -11

Cup Wheel Dual Segment 复式磨轮

适用于花岗岩, 混凝土, 砖块等
各种材料的切割
Applying to various material
grinding granite, concrete, brick.

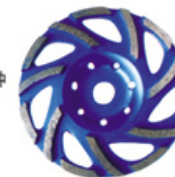

MM	Inch	Thickness	Bore
105	4"	5.0	20/M14/5/8" -11
115	4.5"	5.0	22.2/M14/5/8" -11
125	5"	5.0	22.2/M14/5/8" -11
150	6"	5.0	22.2/M14/5/8" -11
180	7"	5.0	22.2/M14/5/8" -11

Cup Wheel Leaves Type 花瓣磨轮

适用于花岗岩, 混凝土, 砖块等
各种材料的切割
Applying to various material
grinding granite, concrete, brick.



MM	Inch	Thickness	Bore
105	4"	5.0	20/M14/5/8" -11
115	4.5"	5.0	22.2/M14/5/8" -11
125	5"	5.0	22.2/M14/5/8" -11
150	6"	5.0	22.2/M14/5/8" -11
180	7"	5.0	22.2/M14/5/8" -11

Cup Wheel Flat Bond 平板磨轮

适用于花岗岩, 混凝土, 砖块等
各种材料的切割
Applying to various material
grinding granite, concrete, brick.

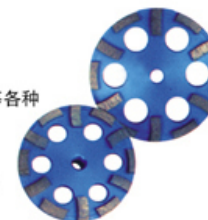

MM	Inch	Thickness	Bore
105	4"	5.0	20/M14/5/8" -11
115	4.5"	5.0	22.2/M14/5/8" -11
125	5"	5.0	22.2/M14/5/8" -10
150	6"	5.0	22.2/M14/5/8" -10
180	7"	5.0	22.2/M14/5/8" -11

Aluminum Base Cup Wheel Straight Teeth 直齿波磨

适用于花岗岩, 混凝土, 砖块等
各种材料的切割
Applying to various material
grinding granite, concrete, brick.



MM	Inch	Thickness	Height	Bore
100	4"	7	20	20/M14/5/8" -11
115	4.5"	7	20	22.2/M14/5/8" -11
125	5"	7	20	22.2/M14/5/8" -10
150	6"	7	20	22.2/M14/5/8" -11
180	7"	7	20	22.2/M14/5/8" -11

Water Drop Single 滴水单磨

适用于花岗岩等各种材料的
切割
Applying to various material
cutting granite.



MM	Inch	Thickness	Bore
100	4"	6	20/M14/5/8" -11
115	4.5"	6	22.2/M14/5/8" -11
125	5"	6	22.2/M14/5/8" -11
180	7"	6	22.2/M14/5/8" -11
230	9"	6	22.2/M14/5/8" -11

Water Drop Double 滴水双磨

适用于花岗岩, 混凝土等各种
材料的切割
Applying to various material
cutting granite, concrete.



MM	Inch	Thickness	Bore
100	4"	5/6	20/M14/5/8" -11
115	4.5"	5/6	22.2/M14/5/8" -11
125	5"	5/6	22.2/M14/5/8" -11
180	7"	5/6	22.2/M14/5/8" -11
230	9"	5/6	22.2/M14/5/8" -11

Strengthened Super Thin Turbo Type For Ceramic & Tile Specially 陶瓷专用超薄加强型(细齿, 方齿)

陶瓷专用型
Special-purpose type of ceramics.

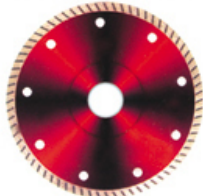

MM	Inch	Thickness	Height	Bore
105	4"	1.8	8/10	20
115	4.5"	1.8	8/10	22.2
125	5"	1.8	8/10	22.2
150	6"	2.0	8/10	22.2/25.4
180	7"	2.0	8/10	22.2/25.4
230	9"	2.4	8/10	22.2/25.4

Strengthened Super Thin Rim Type For Ceramic & Tile Specially 陶瓷专用超薄加强型(湿片)

陶瓷专用型
Special-purpose type of ceramics.

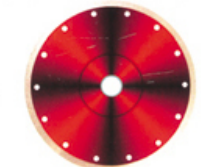

MM	Inch	Thickness	Height	Bore
105	4"	1.2	8/10	20
115	4.5"	1.2	8/10	22.2
125	5"	1.4	8/10	22.2
150	6"	1.4	8/10	22.2/25.4
180	7"	1.6	8/10	22.2/25.4
200	8"	1.6	8/10	22.2/25.4
230	9"	1.8	8/10	22.2/25.4
250	10"	2.0	8/10	22.2/25.4
300	12"	2.2	8/10	22.2/25.4
350	14"	2.2	8/10	22.2/25.4

Super Thin Turbo Cutting Blades For Ceramic & Tile 陶瓷专用超薄细齿

陶瓷专用型
Special-purpose type of ceramics.



MM	Inch	Thickness	Height	Bore
105	4"	1.2	7	20
115	4.5"	1.2	7	22.2
125	5"	1.4	7	22.2
150	6"	1.4	7	22.2/25.4
180	7"	1.6	7	22.2/25.4
230	9"	1.6	7	22.2/25.4

Super Thin Wet Cutting Blades For Ceramic & Tile 陶瓷专用超薄湿片

陶瓷专用型
Special-purpose type of ceramics.

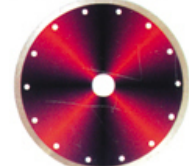

MM	Inch	Thickness	Height	Bore
105	4"	1.2	8/10	20
115	4.5"	1.2	8/10	22.2
125	5"	1.2	8/10	22.2
150	6"	1.4	8/10	22.2/25.4
180	7"	1.4	8/10	22.2/25.4
200	8"	1.6	8/10	22.2/25.4
230	9"	1.6	8/10	22.2/25.4
250	10"	1.8	8/10	22.2/25.4
300	12"	2.2	8/10	22.2/25.4
350	14"	2.2	8/10	22.2/25.4

Super Thin Turbo Cutting Blades For Marble 大理石专用

陶瓷专用型
Special-purpose type of ceramics.

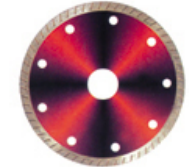

MM	Inch	Thickness	Height	Bore
105	4"	1.6	8/10	20
115	4.5"	1.8	8/10	22.2
125	5"	1.8	8/10	22.2
150	6"	2.0	8/10	22.2/25.4
180	7"	2.0	8/10	22.2/25.4
200	8"	2.2	8/10	22.2/25.4
230	9"	2.4	8/10	22.2/25.4
250	10"	2.4	8/10	22.2/25.4
300	12"	3.0	8/10	22.2/25.4
350	14"	3.0	8/10	22.2/25.4

Hot Pressed Sintered J-Slot Rim Blade

陶瓷专用型
Special-purpose type of ceramics.



Diameter	Item No.	Seg.Width	Seg.Height	Arbor
4"(105mm)	XS105	1.7mm	7mm	7/8", 20mm
4-1/4"(110mm)	XS110	1.7mm	7mm	7/8", 20mm
4.5"(115mm)	XS115	1.7mm	7mm	7/8", 20mm
5"(125mm)	XS125	1.7mm	7mm	7/8", 20mm
6"(150mm)	XS150	1.7mm	7mm	7/8", 20mm
7"(180mm)	XS180	1.7mm	7mm	7/8"
8"(200mm)	XS200	1.8mm	7mm	7/8", 5/8"
9"(230mm)	XS230	2.0mm	7mm	7/8", 5/8"
10"(250mm)	XS250	2.0mm	7mm	7/8", 5/8"
12"(300mm)	XS300	2.2mm	7mm	50mm, 1", 20mm
14"(350mm)	XS350	2.4mm	7mm	50mm, 1", 20mm

Segmented Turbo

适用于花岗岩,混凝土,砖块等各种材料的切割
Applying to various material cutting granite, concrete, brick.

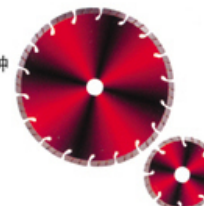

MM	Inch	Thickness	Height	Bore
105	4"	2.0	8	20
115	4.5"	2.0	8	22.2
125	5"	2.2	8	22.2
150	6"	2.2	8	22.2
180	7"	2.2	8	22.2
230	9"	2.4	8	22.2
300	12"	3.4	10	20/25.4
350	14"	3.5	10	20/25.4

Middle & Big Teeth Turbo

适用于花岗岩,陶瓷等各种材料的切割
Applying to various material cutting granite, ceramics.

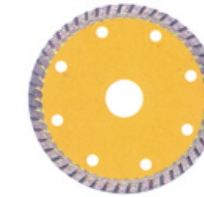

MM	Inch	Thickness	Height	Bore
105	4"	2.0	8/10	20
115	4.5"	2.0	8/10	22.2
125	5"	2.2	8/10	22.2
150	6"	2.2	8/10	22.2/25.4
180	7"	2.2	8/10	22.2/25.4
200	8"	2.4	8/10	22.2/25.4
230	9"	2.6	8/10	22.2/25.4
300	12"	3.2	8/10	22.2/25.4
350	14"	3.2	8/10	22.2/25.4

Multi-segmented Blades

适用于花岗岩,混凝土等各种材料的切割
Applying to various material cutting granite, concrete.



MM	Inch	Thickness	Height	Bore
105	4"	2.0	8	20
115	4.5"	2.2	8	22.2
125	5"	2.4	8	22.2
150	6"	2.4	8	22.2
180	7"	2.4	8	22.2
230	9"	2.8	8	22.2

Turbo Wave

适用于花岗岩,大理石,混凝土,砖块等各种材料的切割
Applying to various material cutting granite, marble, concrete, brick.



MM	Inch	Height	Bore
105	4"	8	20
115	4.5"	8	22.2
125	5"	8	22.2
150	6"	8	22.2/25.4
180	7"	8	22.2/25.4
230	9"	8	22.2/25.4

Turbo Wave With Thread Flange

适用于花岗岩,大理石,陶瓷等各种材料的切割
Applying to various material cutting granite, marble, ceramics.



MM	Inch	Height	Bore
105	4"	8/10	M10/M14
115	4.5"	8/10	M10/M14
125	5"	8/10	M10/M14
150	6"	8/10	M14
180	7"	8/10	M14
230	9"	8/10	M14

Turbo Wave With Normal Flange

适用于花岗岩,大理石,陶瓷等各种材料的切割
Applying to various material cutting granite, marble, ceramics.

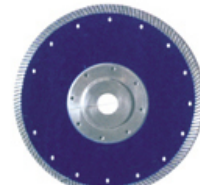

MM	Inch	Height	Bore
150	6"	8/10	22.2
180	7"	8/10	22.2
230	9"	8/10	22.2

Core Bits Dry Type

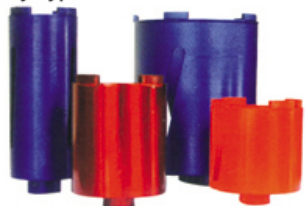

MM	Inch	Height	Bore
38	7/10	7/10	M16G1/2"
52	7/10	7/10	M16G1/2"
68	7/10	7/10	M16G1/2"
72	7/10	7/10	M16G1/2"
82	7/10	7/10	M16G1/2"
107	4"	7/10	M16G1/2"
117	4.55"	7/10	M16G1/2"
127	5"	7/10	M16G1/2"
152	6"	7/10	M16G1/2"

适用于花岗岩,
混凝土, 砖块等
各种材料的切割

Applying to various
material granite,brick.

Strengthened Core Bits Dry Type

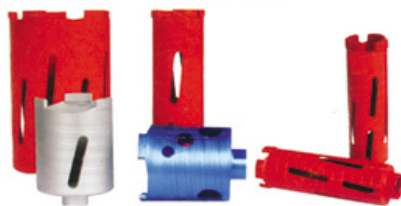

MM	Inch	Height	Bore
38	7/10	7/10	M16G1/2"
52	7/10	7/10	M16G1/2"
68	7/10	7/10	M16G1/2"
72	7/10	7/10	M16G1/2"
82	7/10	7/10	M16G1/2"
107	4"	7/10	M16G1/2"
117	4.55"	7/10	M16G1/2"
127	5"	7/10	M16G1/2"
152	6"	7/10	M16G1/2"

适用于花岗岩,
混凝土, 砖块等
各种材料的切割

Applying to various
material granite,brick.

Diamond Core Drill

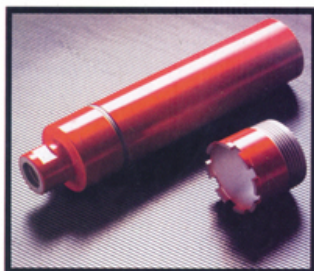

Diamond Core Drill Bit with 1-1/4" UNC thread:

20x450mm, 25x450mm, 32x450mm, 42x450mm, 52x450mm, 62x450mm, 72x450mm, 82x450mm, 92x450mm, 102x450mm, 112x450mm, 122x450mm, 132x450mm, 142x450mm, 152x450mm, 162x450mm, 172x450mm, 82x450mm, 192x450mm, 202x450mm, 212x450mm, 220x450mm, 250x450mm, 300x450mm

Diamond coredrills with M16 thread short type with SDS PLUS/HEX Shank

30mm, 35mm, 40mm, 45mm, 50mm, 55mm, 60mm, 65mm, 68mm, 70mm, 75mm, 80mm, 82mm, 90mm, 95mm, 102mm, 125mm

Connector

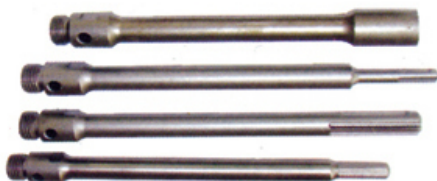

Transfer



Core Bits For Ceramic & Tile Specially T瓷砖打孔钻

MM	Inch	Height	Bore
6	1.0	10	G1/2" M14
8	1.0	10	G1/2" M14
10	1.0	10	G1/2" M14
12	1.0	10	G1/2" M14
15	1.0	10	G1/2" M14
20	1.0	10	G1/2" M14
25	1.0	10	G1/2" M14
30	1.0	10	G1/2" M14
35	1.0	10	G1/2" M14
40	1.0	10	G1/2" M14
45	1.5	10	G1/2" M14
50	1.5	10	G1/2" M14
55	1.5	10	G1/2" M14
60	1.5	10	G1/2" M14
65	1.5	10	G1/2" M14
70	1.5	10	G1/2" M14
75	1.5	10	G1/2" M14
80	2.0	10	G1/2" M14
82	2.0	10	G1/2" M14



Water Supplying Valve 陶瓷、玻璃专用供水阀

头部	尾部
G1/2"	G1/2"
六闸	G1/2"
SDS	G1/2"
M16	G1/2"
M14	M14
5/8" -11	5/8" -11



Locator 定位器



Inner/Outer Cleaner 内外吸尘器



7Pcs Diamond Core Bit Sets

Size(mm): 38,52,117mm
Accessories: 1pc Hex Adapter 240mm;
1pc SDS Adapter 240mm;
1pc Pilot Drill 200mm;
1pc Taper Drill 60mm.



11Pcs Diamond Core Bit Sets

Size(mm): 38,52,65,117,127mm
Accessories: 1pc G1/2" Hex Adapter 240mm;
1pc SDS Adapter 240mm;
1pc SDS Adapter 88mm;
1pc Hex Adapter 88mm;
1pc Pilot Drill 200mm;
1pc Taper Drill 60mm.





TCT Saw Blade For Wood



- 4"x12T 5"x40T 7"x80T 9"x60T 12"x40T 16"x60T
- 4"x16T 6"x24T 8"x24T 9"x80T 12"x80T 16"x80T
- 4"x20T 6"x30T 8"x30T 10"x24T 12"x100T 16"x100T
- 4"x24T 6"x36T 8"x40T 10"x36T 12"x120T 16"x120T
- 4"x30T 6"x40T 8"x60T 10"x40T 14"x40T 18"x40T
- 4"x40T 6"x60T 8"x80T 10"x60T 14"x60T 18"x60T
- 5"x20T 7"x24T 9"x24T 10"x80T 14"x80T 18"x80T
- 5"x24T 7"x36T 9"x30T 10"x100T 14"x100T 18"x100T
- 5"x30T 7"x40T 9"x36T 10"x120T 18"x120T 18"x120T
- 5"x36T 7"x60T 9"x40T 12"x24T 16"x40T

TCT Saw Blade For Aluminium



- 8"x80T
- 9"x80T
- 10"x100T
- 10"x120T
- 12"x100T
- 12"x120T
- 16"x100T
- 16"x120T

TCT Saw Blade For Metal



- 115mmx20T 125mmx20T
- 135mmx32T 160mmx32T
- 180mmx36T 190mmx40T
- 200mmx40T 230mmx48T
- 250mmx56T 300mmx64T

TCT Saw Blade For Grass



- 9"x2.0x1.3x25.4x36T
- 9"x2.2x1.3x25.4x36T
- 9"x2.0x1.3x25.4x40T
- 9"x2.2x1.3x25.4x40T
- 10"x2.0x1.3x25.4x40T
- 10"x2.2x1.3x25.4x40T
- 10"x2.0x1.3x25.4x60T
- 10"x2.2x1.3x25.4x60T

ISO直槽机用丝锥 Hss Solid Ground Machine Taps(Straight Flute)
Metric ISO Coarse and Fine Thread Form



D	粗牙: MC		细牙: MF	
	L ₁	L ₂	L ₁	L ₂
M1.4x0.30	40	7	M1.4x0.20	40 7
M1.6x0.35	41	8	M1.6x0.20	41 8
M1.8x0.35	41	8	M1.8x0.20	41 8
M2x0.40	41	8	M2.0x0.25	41 8
M2.2x0.45	44.5	9.5	M2.2x0.25	44.5 9.5
M2.5x0.45	44.5	9.5	M2.5x0.35	44.5 9.5
M3x0.50	48	11	M3x0.35	48 11
M3.5x0.60	50	13	M3.5x0.35	50 13
M4x0.70	53	13	M4x0.50	53 13
M4.5x0.75	53	13	M4.5x0.50	53 13
M5x0.80	58	16	M5x0.50	58 16
M6x1.00	66	19	M5.5x0.50	62 17
M7x1.00	66	19	M6x0.50	66 19
M8x1.25	72	22	M6x0.75	66 19
M9x1.25	72	22	M7x0.75	66 19
M10x1.50	80	24	M8x0.75	66 19
M11x1.00	80	22	M8x1.00	72 22
M11x1.25	85	25	M9x0.75	66 19
M11x1.50	85	25	M9x1.00	72 22
M12x1.00	80	22	M10x0.75	73 20
M12x1.25	89	29	M10x1.00	80 24
M12x1.50	89	29	M10x1.25	80 24
M12x1.75	89	29	M11x0.75	80 22
M14x1.00	87	22	M11x1.00	80 22
M14x1.25	95	30	M12x1.00	80 22
M14x1.50	95	30	M12x1.25	89 29
M14x2.00	95	30	M12x1.50	89 29
M16x1.00	92	22	M14x1.00	87 22
M16x1.50	102	32	M14x1.25	95 30
M16x2.00	102	32	M14x1.50	95 30
M17x1.00	92	22	M16x1.00	92 22
M17x1.50	102	32	M16x1.50	102 32
M18x1.00	97	22	M18x1.00	97 22
M18x1.50	112	37	M18x1.50	112 37
M18x2.00	112	37	M18x2.00	112 37
M18x2.50	112	37	M20x1.00	102 22
M20x1.00	102	22	M20x1.50	112 37
M20x1.50	112	37	M20x2.00	112 37
M20x2.00	112	37	M22x1.00	109 24
M20x2.50	112	37	M22x1.50	118 38
M22x1.00	109	24	M22x2.00	118 38
M22x1.50	118	38	M24x1.00	114 24
M22x2.00	118	38	M24x1.50	130 45
M22x2.50	118	38	M24x2.00	130 45
M24x1.00	114	24	M27x1.00	120 25
M24x1.50	130	45	M27x1.50	127 37
M24x2.00	130	45	M27x2.00	127 37
M24x3.00	130	45		
M25x1.50	130	45		
M25x2.00	130	45		
M26x1.00	120	25		
M26x1.50	120	35		
M27x1.00	120	25		
M27x1.50	127	37		
M27x2.00	127	37		
M27x3.00	135	45		



ISO全磨制螺旋槽丝锥 Hss Solid Ground Machine Taps(Spiral Flute)
Metric ISO Coarse and Fine Thread Form



D	粗牙: MC		细牙: MF	
	L ₁	L ₂	L ₁	L ₂
M3x0.50	48	11	M3x0.35	48 11
M3.5x0.60	50	13	M3.5x0.35	50 13
M4x0.70	53	13	M4x0.50	53 13
M4.5x0.75	53	13	M4.5x0.50	53 13
M5x0.80	58	16	M5x0.50	58 16
M6x1.00	66	19	M5.5x0.50	62 17
M7x1.00	66	19	M6x0.50	66 19
M8x1.25	72	22	M6x0.75	66 19
M9x1.25	72	22	M7x0.75	66 19
M10x1.50	80	24	M8x0.75	66 19
M11x1.00	80	22	M8x1.00	72 22
M11x1.25	85	25	M9x0.75	66 19
M11x1.50	85	25	M9x1.00	72 22
M12x1.00	80	22	M10x0.75	73 20
M12x1.25	89	29	M10x1.00	80 24
M12x1.50	89	29	M10x1.25	80 24
M12x1.75	89	29	M12x1.00	80 22
M14x1.00	87	22	M12x1.25	89 29
M14x1.25	95	30	M12x1.50	89 29
M14x1.50	95	30	M14x1.00	87 22
M14x2.00	95	30	M14x1.25	95 30
M16x1.00	92	22	M14x1.50	95 30
M16x1.50	102	32	M16x1.00	92 22
M16x2.00	102	32	M16x1.50	102 32

ISO全磨制挤压丝锥 Hss Solid Ground Machine Taps(Fluteless Taps)
Metric ISO Coarse and Fine Thread Form



D	粗牙: MC		细牙: MF	
	L ₁	L ₂	L ₁	L ₂
M2x0.40	41	8	M2x0.25	41 8
M2.2x0.45	44.5	9.5	M2.2x0.25	44.5 9.5
M2.5x0.45	44.5	9.5	M2.5x0.35	44.5 9.5
M3x0.50	48	14.5	M3x0.35	48 14.5
M3.5x0.60	50	16.5	M3.5x0.35	50 16.5
M4x0.70	53	17	M4x0.50	53 17
M4.5x0.75	53	17	M4.5x0.50	53 17
M5x0.80	58	16	M5x0.50	58 16
M6x1.00	66	19	M6x0.75	66 19
M7x1.00	66	19	M7x0.75	66 19
M8x1.25	72	22	M8x1.00	69 19
M9x1.25	72	22	M10x1.00	76 20
M10x1.50	80	24	M10x1.25	76 20
M11x1.50	85	25	M12x1.25	84 24
M12x1.75	89	29	M12x1.50	89 29
M14x2.00	95	30	M14x1.25	90 25
M16x2.00	102	32	M14x1.50	95 30
			M16x1.50	102 32

全磨制统一一螺纹(UN)直槽丝锥 Hss Solid Ground Machine Taps
(Straight Flute) Unified Coarse(UNC)and Fine(UNF) Thread



全磨制统一一螺纹(UN)螺旋槽丝锥 Hss Solid Ground Machine Taps
(Spiral Flute) Unified Coarse(UNC)and Fine(UNF) Thread



全磨制统一一螺纹(UN)螺尖丝锥 Hss Solid Ground Machine Taps
(Straight Flute Spiral Point) Unified Coarse(UNC)and Fine(UNF) Thread



全磨制统一一螺纹(UN)挤压丝锥 Hss Solid Ground Machine Taps
(Fluteless Taps) Unified Coarse(UNC)and Fine(UNF) Thread



D	粗牙: UNC		细牙: UNF	
	L ₁	L ₂	L ₁	L ₂
No.5-40	49.21	15.88	No.5-44	49.21 15.88
No.6-32	50.80	17.46	No.6-40	50.80 17.46
No.8-32	53.98	19.05	No.8-36	53.98 19.05
No.10-24	60.33	22.23	No.10-32	60.33 22.23
No.12-24	60.33	23.81	No.12-28	60.33 23.81
1/4-20	63.50	25.40	1/4-28	63.50 25.40
5/16-18	69.06	29.63	5/16-24	69.06 29.63
3/8-16	74.61	31.75	3/8-24	74.61 31.75
7/16-14	76.99	30.51	7/16-20	76.99 30.51
1/2-13	79.38	42.07	1/2-20	79.38 42.07
9/16-12	91.28	42.07	9/16-18	91.28 42.07
5/8-11	96.84	46.04	5/8-18	96.84 46.04
3/4-10	107.95	50.80	3/4-16	107.95 50.80
7/8-9	119.06	56.36	7/8-14	119.06 56.36
1-8	130.18	63.50	1-12	130.18 63.50

全磨制55° 螺纹(BS)直槽丝锥 Hss Solid Ground Machine Taps
(Straight Flute) British Whitworth (BSW) and Fine(BSF) Thread



全磨制55° 螺纹(BS)螺旋槽丝锥 Hss Solid Ground Machine Taps
(Spiral Flute) British Whitworth (BSW) and Fine(BSF) Thread



全磨制55° 螺纹(BS)螺尖丝锥 Hss Solid Ground Machine Taps
(Straight Flute Spiral Point) British Whitworth (BSW) and Fine(BSF) Thread



全磨制55° 螺纹(BS)挤压丝锥 Hss Solid Ground Machine Taps
(Fluteless Taps) British Whitworth (BSW) and Fine(BSF) Thread



D	粗牙: BSW		细牙: BSF	
	L ₁	L ₂	L ₁	L ₂
1/8-40	48	11	1/4-26	66 19
3/16-24	58	16	9/32-26	66 19
1/4-20	66	19	5/16-22	72 22
5/16-18	72	22	3/8-20	80 24
3/8-16	80	24	5/16-22	72 22
7/16-14	85	25	3/8-20	80 24
1/2-12	89	29	7/16-18	85 25
9/16-12	95	30	1/2-16	89 29
5/8-11	102	32	9/16-16	95 30
3/4-10	112	37	5/8-14	102 32
7/8-9	118	38	3/4-12	112 37
1-8	130	45	7/8-11	118 38
3/16-32	58	16	1-10	130 45
7/32-28	62	17		

全磨制DIN371丝锥 DIN371 Hss Solid Ground Machine Taps Metric Coarse and Fine Thread



粗牙: MC			细牙: MF		
D	L ₁	L ₂	D	L ₁	L ₂
M3x0.50	56	11	M3x0.35	56	11
M3.5x0.60	56	13	M3.5x0.35	56	11
M4x0.70	63	13	M4x0.50	63	13
M4.5x0.75	70	16	M4.5x0.50	70	16
M5x0.80	70	16	M5x0.50	70	16
M6x1.00	80	19	M6x0.50	80	19
M7x1.00	80	19	M6x0.75	80	19
M8x1.25	90	22	M7x0.75	80	19
M9x1.25	90	22	M8x0.75	90	22
M10x1.50	100	24	M8x1.00	90	22
			M9x0.75	90	22
			M9x1.00	90	22
			M10x1.00	100	24
			M10x1.25	100	24

全磨制DIN374丝锥 DIN374 Hss Solid Ground Machine Taps Metric

细牙: MF			细牙: MF		
D	L ₁	L ₂	D	L ₁	L ₂
M3x0.35	56	10	M15x1.00	100	22
M3.5x0.35	56	10	M15x1.50	100	22
M4x0.50	63	10	M16x1.00	100	22
M4.5x0.50	70	12	M16x1.50	100	22
M5x0.50	70	12	M18x1.00	110	25
M6x0.50	80	14	M18x1.50	110	25
M6x0.75	80	14	M18x2.00	125	34
M7x0.75	80	14	M20x1.00	125	25
M8x0.75	80	19	M20x1.50	125	25
M8x1.00	90	22	M20x2.00	140	34
M9x1.00	90	22	M22x1.00	125	25
M10x0.75	90	22	M22x1.50	125	25
M10x1.00	90	20	M22x2.00	140	34
M10x1.25	100	24	M24x1.00	140	28
M11x1.00	90	20	M24x1.50	140	28
M12x1.00	100	22	M24x2.00	140	28
M12x1.25	100	22	M25x1.50	140	28
M12x1.50	100	22	M26x1.50	140	28
M14x1.00	100	22	M27x1.50	140	28
M14x1.25	100	22	M27x2.00	140	28
M14x1.50	100	22			

全磨制DIN352丝锥 DIN352 Hss Solid Ground Machine Taps Metric



粗牙: MC			粗牙: MC		
D	L ₁	L ₂	D	L ₁	L ₂
M3x0.50	40	11	M11x1.50	70	24
M3.5x0.60	45	13	M12x1.75	75	29
M4x0.70	45	13	M14x2.00	80	30
M4.5x0.75	50	16	M16x2.00	80	32
M5x0.80	50	16	M18x2.50	95	40
M6x1.00	50	19	M20x2.50	95	40
M7x1.00	50	19	M22x2.50	100	40
M8x1.25	56	22	M24x3.00	110	50
M9x1.25	63	22	M27x3.00	110	50
M10x1.50	70	24			

全磨制DIN376丝锥 DIN376 Hss Solid Ground Machine Taps Metric



粗牙: MC			粗牙: MC		
D	L ₁	L ₂	D	L ₁	L ₂
M3x0.50	56	11	M11x1.50	100	24
M3.5x0.60	56	12	M12x1.75	110	29
M4x0.70	63	13	M14x2.00	110	30
M4.5x0.75	70	16	M16x2.00	110	32
M5x0.80	70	16	M18x2.50	125	34
M6x1.00	80	19	M20x2.50	140	34
M7x1.00	80	19	M22x2.50	140	34
M8x1.25	90	22	M24x3.00	160	38
M9x1.25	90	22	M27x3.00	160	38
M10x1.50	100	24			

DIN352高速钢HSS丝锥 DIN352 Hss Taps(3pcs Set)



D	L ₁	L ₂	D	L ₁	L ₂
M1x0.25	32	5.5	M11x1.50	70	24
M1.1x0.25	32	5.5	M12x1.75	75	29
M1.2x0.25	32	5.5	M14x2.00	80	30
M1.4x0.30	32	7	M16x2.00	80	32
M1.6x0.35	32	8	M18x2.50	95	40
M1.7x0.35	32	8	M20x2.50	95	40
M1.8x0.35	32	8	M22x2.50	100	40
M2x0.40	36	8	M24x3.00	110	50
M2.2x0.45	36	9	M27x3.00	110	50
M2.3x0.40	36	9	M30x3.50	125	56
M2.5x0.45	40	9	M33x3.50	125	56
M2.6x0.45	40	9	M36x4.00	150	63
M3x0.50	40	11	M39x4.00	150	63
M3.5x0.60	45	13	M42x4.50	150	63
M4x0.70	45	13	M45x4.50	160	70
M4.5x0.75	50	16	M48x5.00	180	75
M5x0.80	50	16	M52x5.00	180	75
M6x1.00	50	19	M56x5.50	200	85
M7x1.00	50	19	M60x5.50	200	85
M8x1.25	56	22	M64x6.00	220	90
M9x1.25	63	22	M68x6.00	220	90
M10x1.50	70	24			

DIN352合金钢, Alloy丝锥 DIN352 Alloy Steel Taps(3pcs Set)

D	L ₁	L ₂	D	L ₁	L ₂
M2x0.40	36	8	M12x1.75	75	29
M2.5x0.45	40	9	M14x2.00	80	30
M3x0.50	40	11	M16x2.00	80	32
M4x0.70	45	13	M18x2.50	95	40
M5x0.80	50	16	M20x2.50	95	40
M6x1.00	50	19	M22x2.50	100	40
M7x1.00	50	19	M24x3.00	110	50
M8x1.25	56	22	M27x3.00	110	50
M9x1.25	63	22	M30x3.00	125	56
M10x1.50	70	24	M30x3.50	125	56
			M33x3.50	125	56
			M36x4.00	150	63

管螺纹丝锥 Pipe Taps

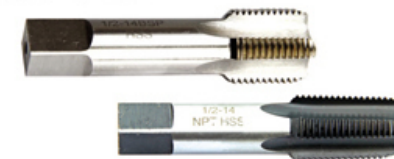

ANSI Taper Pipe Tap/Jumping Thread Tap			ANSI Straight Pipe Taps		
D	L ₁	L ₂	D	L ₁	L ₂
1/16-27NPT	2-1/8	11/16	1/16-27NPS	2-1/8	11/16
1/8-27NPT	2-1/8	3/4	1/8-27NPS	2-1/8	3/4
1/4-18NPT	2-7/16	1-1/16	1/4-18NPS	2-7/16	1-1/16
3/8-18NPT	2-9/16	1-1/16	3/8-18NPS	2-9/16	1-1/16
1/2-14NPT	3-1/8	1-3/8	1/2-14NPS	3-1/8	1-3/8
3/4-14NPT	3-1/4	1-3/8	3/4-14NPS	3-1/4	1-3/8
1-11-1/2NPT	3-3/4	1-3/4	1-11-1/2NPS	3-3/4	1-3/4
1-1/4-11-1/2NPT	4	1-3/4	1-1/4-11-1/2NPS	4	1-3/4
1-1/2-11-1/2NPT	4-1/4	1-3/4	1-1/2-11-1/2NPS	4-1/4	1-3/4
2-11-1/2NPT	4-1/2	1-3/4	2-11-1/2NPS	4-1/2	1-3/4
2-1/2-8NPT	5-1/2	2-9/16	2-1/2-8NPS	5-1/2	2-9/16
3-8NPT	6	2-5/8	3-8NPS	6	2-5/8
3-1/2-8NPT	6-1/2	2-11/16	3-1/2-8NPS	6-1/2	2-11/16
4-8NPT	6-3/4	2-3/4	4-8NPS	6-3/4	2-3/4

管螺纹二支组丝锥 2Pcs Pipe Taps Set



DIN 5157 Straight Pipe Tap			DIN 5156 Straight Pipe Tap		
D	L ₁	L ₂	D	L ₁	L ₂
G1/16-28	56	22	G1/16-28	90	22
G1/8-28	63	20	G1/8-28	90	20
G1/4-19	70	22	G1/4-19	100	22
G3/8-19	70	22	G3/8-19	100	22
G1/2-14	80	22	G1/2-14	125	25
G5/8-14	80	22	G5/8-14	125	25
G3/4-14	90	22	G3/4-14	140	28
G7/8-14	90	22	G7/8-14	150	28
G1-11	100	25	G1-11	160	30
G1-1/8-11	125	40	G1-1/8-11	170	30
G1-1/4-11	125	40	G1-1/4-11	170	30
G1-1/2-11	140	40	G1-1/2-11	190	32
G1-3/4-11	160	40	G1-3/4-11	190	32
G2-11	160	40	G2-11	220	40

DIN2181公制螺纹二支组不等径丝锥 DIN2181 Hss Taps(2pcs Set)



D	L1	L2	D	L1	L2
M3x0.35	40	9	M18x1.50	80	22
M4x0.35	45	10	M18x2.00	80	22
M4x0.50	45	10	M20x1.00	80	22
M5x0.50	50	12	M20x1.25	80	22
M6x0.50	50	14	M20x1.50	80	22
M6x0.75	50	14	M22x2.00	80	22
M7x0.75	50	14	M22x1.00	80	22
M8x0.50	50	19	M22x1.50	80	22
M8x0.75	50	19	M22x2.00	80	22
M8x1.00	56	22	M24x1.00	90	22
M9x1.00	63	22	M24x1.50	90	22
M10x0.75	63	20	M24x2.00	90	22
M10x1.00	63	20	M25x1.50	90	22
M10x1.25	70	24	M26x1.50	90	22
M11x1.00	63	20	M26x2.00	90	22
M12x1.00	70	22	M27x1.50	90	22
M12x1.25	70	22	M27x2.00	90	22
M12x1.50	70	22	M28x1.50	90	22
M13x1.00	70	22	M28x2.00	90	22
M13x1.50	70	22	M30x1.00	90	22
M14x1.00	70	22	M30x1.50	90	22
M14x1.25	70	22	M30x2.00	90	22
M14x1.50	70	22	M32x1.50	90	22
M15x1.00	70	22	M33x1.50	100	25
M15x1.50	70	22	M33x2.00	100	25
M16x1.00	70	22	M34x1.50	100	25
M16x1.50	70	22	M35x1.50	100	25
M18x1.00	80	22	M36x1.50	100	25
M18x1.25	80	22			

机用和手用圆板牙 Round Die / Hexagon Die / Adjustable Die (UNF,UNC,BSF,BSW,NPT)

Material: HSS, Alloy Steel
Standard: DIN, ISO, ANSI
Size range: M2~M52, 4-40~1-1/2", NPT1/8~2"



板牙扳手 DIE Handle DIN225



Size	For Die size			L
	Metric	UNC/UNF	Pipe	
16x5	M1-M2.6	1/16~3/32		160
20x5	M3-M4	1/8~5/32		200
20x7	M4.5-M6	13/16~1/4		200
25x9	M7-M9	5/16	G1/16	224
30x11	M10-M11	3/8~7/16	G1/8	280
38x14	M12-M14	1/2~9/16		315
38x10	MF12-MF14		G1/4	315
45x18	M16-M20	5/8~3/4		450
45x14	MF16-MF20		G3/8-G1/2	450
55x22	M22-M24	7/8~1~11		560
55x16	MF21-MF26		G5/8-G3/4	560
65x25	M27-M36	1-1/8~1-3/8		630
65x18	MF27-MF36		G7/8-G1-11	630
75x30	M39-M42	1-1/2~1-5/8		800
75x20	MF38-MF42		G1-1/8-G1-1/4	800
90x36	M45-M52	1-3/4~2-11		900
90x22	MF45-MF52		G1-1/2	900
105x22	M55-M62	G1-3/4~G2-11		1000

钻头复合丝锥 Hss Drill & Taps Combination



D	L1
M3x0.50	36
M4x0.70	39
M5x0.80	41
M6x1.00	44
M7x1.00	49
M8x1.25	49
M10x1.50	52
M12x1.75	

丝锥扳手 Tap Wrench DIN1814



No	For tap size			L
	Metric	UNC/UNF	Pipe	
0	M1-M8	1/16~1/4		125
1	M3-M10	1/8~3/8		180
1-1/2	M3-M12	1/8~1/2	G1/8	200
2	M4-M12	3/16~5/8	G1/8-G3/8	280
3	M5-M20	1/4~3/4	G1/8-G1/2	375
4	M10-M27	3/8~1-11	G1/8~G3/4	500
5	M14-M33	5/8~1-1/4	G1/4~G1-11	750

14pcs Tap & Drill Set

DIN371 Tap Size:
M3x0.5, M4x0.7, M5x0.8, M6x1.0, M8x1.25, M10x1.5, M12x1.75
DIN338 Drill Size:
2.5mm, 3.3mm, 4.2mm, 5.0mm, 6.8mm, 8.5mm, 10.2mm

XS-T1401

21pcs Metric Tap Set

DIN352 Tap Size:
3pcs each: M3x0.5, M4x0.7, M5x0.8, M6x1.0, M8x1.25, M10x1.5, M12x1.75

XS-T2101

29pcs Metric Tap Set

DIN352 Tap Size:
3pcs each: M3x0.5, M4x0.7, M5x0.8, M6x1.0, M8x1.25, M10x1.5, M12x1.75
1pc Tap Wrench

XS-T2901

20pcs Metric Tap & Die Set / 20pcs UNC Tap & Die Set

Tap & Die Metric Size: M3x0.5, M4x0.7, M5x0.8, M6x1.0, M7x1.0, M8x1.25, M9x1.25, M10x1.5, M12x1.75
Tap & Die UNC Size: 6-32, 8-32, 10-24, 12-24, 1/4-20, 5/16-18, 3/8-16, 7/16-14, 1/2-13
1pc Tap Wrench 1pc Die Handle O/D 1"

XS-T2001

24pcs Metric Tap & Die Set / 24pcs UNC & UNF Tap & Die Set

11pcs Tap & Die Size: M5x0.8, M5x0.9, M6x0.75, M6x1.0, M8x1.0, M8x1.25, M10x1.25, M10x1.5, M12x1.5, M12x1.75, 1/8-27NPT
1pc Tap Wrench M3-M12
1pc Die Wrench O/D 25mm

XS-T2401

XS-T2402

32pcs Metric Tap Set

Tap & Die Size: Din352 & Din223
M3x0.5, M4x0.7, M5x0.8, M6x1.0, M8x1.25, M10x1.5, M12x1.75
1pc Tap Wrench: M3-M12
1pc Die Stock: O/D 25mm
1pc Screw Driver
1pc Screw Pitch Gauge

XS-T3201

40pcs Metric Tap & Die Set / 40pcs UNC & UNF Tap & Die Set

16pcs Tap & Die Size: M3x0.5, M3x0.6, M4x0.7, M4x0.75, M5x0.8, M5x0.9, M6x0.75, M6x1.0, M7x0.75, M7x1.0, M8x1.0, M8x1.25, M10x1.25, M10x1.5, M12x1.5, M12x1.75, 1/8-27NPT
1pc Tap Wrench: M3-M12
1pc Die Wrench: O/D 25mm
1pc Screwdriver
1pc Screw Pitch Gauge
1pc T Type Tap Wrench

XS-T4001

XS-T4002

45pcs Metric Tap & Die Set / 45pcs UNC & UNF Tap & Die Set

Tap & Die Size: M6x0.75, M6x1.0, M8x1.0, M8x1.25, M10x1.25, M10x1.5, M12x1.5, M12x1.75, M14x1.5, M14x2.0, M16x1.5, M16x2.0, M18x1.5, M18x2.5, M20x1.5, M20x2.5, M22x1.5, M22x2.5, M24x1.5, M24x3.0
1pc Tap Wrench: M8-M25
1pc Die Stock: O/D 50mm
1pc Screw Driver
1pc T Tap Wrench: M3-M6

XS-T4501

110pcs Metric Tap & Die Set / 110pcs Metric & NPT Tap & Die Set

Tap & Die Size: 2x0.4, 3x0.5, 4x0.7, 5x0.8, 6x0.75, 6x1.0, 7x0.75, 7x1.0, 8x0.75, 8x1.0, 8x1.25, 9x0.75, 9x1.0, 9x1.25, 10x0.75, 10x1.0, 10x1.25, 10x1.5, 11x0.75, 11x1.0, 11x1.25, 11x1.5, 12x0.75, 12x1.0, 12x1.25, 12x1.5, 12x1.75, 14x1.0, 14x1.25, 14x1.5, 14x2.0, 16x1.0, 16x1.5, 16x2.0, 18x1.5
1pc Die Stock: O/D 1"
1pc Die Stock: O/D 1/2"
2pcs Tap Wrench
1pc T Type Tap Wrench

XS-T11001

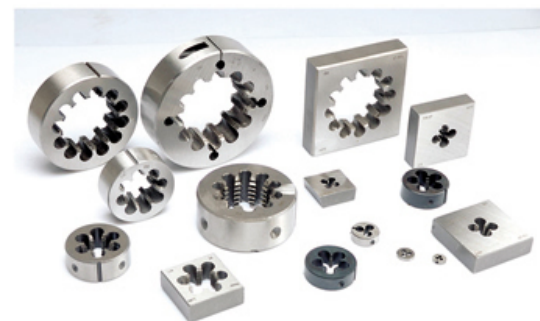

扫一扫手机端访问



添加好友，随时咨询

DANYANG XIANGSHANG TOOLS CO.,LTD.
 Jide Industrial Zone, Houxiang Danbei Town, Danyang City, Jiangsu Province, China
 Contacts: Mrs. Betty - He fangdong
 MOBILE: 008613706108535
 TEL/FAX: 008651186317508
 WhatsApp/Wechat ID: 008613706108535
 E-mail: hfddg@263.net
 sales@xiangshangtools.com